

# 0241-P124

Electronics & Interface > Distribution Module

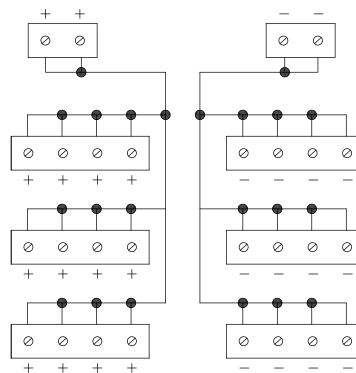

The web catalog is for reference only. Dinkle remains the right of product modification and engineering change of the design. The final product is made according to engineering drawing.

## Specification

Specification	
Distribution type	1 input to 12 output
Number of connections	12+12
L x W x H (mm)	38.2 x 47.9 x 30.3
Connection method	PID
Input	
Input voltage	50 VDC
Max. current of single pole	20 A
Total input current	40 A
Wire range	26~12 AWG
Stripping length	9~10 mm
Applicable ferrules	DN00510D DN00710D DN01510D
Output	
Output voltage	50 VDC
Max. current of single pole	12A (Total output below 40A)
Wire range	26 ~ 16 AWG
Stripping length	8~9 mm
Applicable ferrules	DN00508D DN00708D

## Approvals

---

**RoHS**  **CE**