



**REER**

*Your future's safe!*



**MOSAIC**

modular safety integrated controller

*product catalogue*

**MV**  
Expansion units for safety speed monitoring

**MBx**  
Expansion units for connection to the most common industrial Fieldbus systems for diagnostics and data communication

**MOR4, MOR4S8**  
Safety relay units with configurable outputs

**M1 (Standard) or M1S (Enhanced)**  
Master Unit  
The Master Unit can be used as a stand-alone device or to control other expansion units



**MA4**  
Analog input expansion unit

**Mosaic Safety Communication (MSC)**  
Allows communication between the various units through a proprietary high-speed safety bus

**Removable terminals**  
Two versions available  
- with clamp contacts  
- with screw contacts

**Mix, MOx**  
Additional Input/Output units

**Mosaic Configuration Memory (MCM)**  
Removable memory card for saving Mosaic configuration data for subsequent transfers to a new device (without using a PC) or for backup

**USB Connection**  
USB 2.0 serial bus for the connection to Mosaic Safety Designer (MSD) software

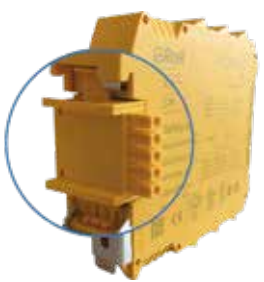

## KEY FEATURES

- Mosaic is a safety hub able to manage all safety functions of a machinery. **Configurable and scalable**, allows **cost reductions** and **minimal wiring**
- Mosaic can manage **safety sensors** and signals such as:
  - Light curtains
  - Photocells
  - Laser scanners
  - Emergency stops
  - Electromechanical switches
  - Guard-lock safety door switches
  - Magnetic switches
  - RFID switches
  - Inductive sensors
  - Safety mats and edges
  - Two-hands controls
  - Hand grip switches
  - Safety switch with guard locking
  - Encoders and proximities for safety speed control
  - Loading cells, pressure switches, temperature measurements, flow and level measurements



SAFETY LEVEL

Up to **SIL 3**

SIL 3 - SILCL 3  
PL e - Cat. 4

## ADVANTAGES

Compared to “traditional” electromechanical safety-relays-based safety circuitries, Mosaic has the following advantages:

- **Reducing the number of devices** and wiring used and, therefore, the overall size of the project
- **Speeding-up control panel construction**
- Providing **logic configuration** via a quick and **easy-to-use software**. Machine designers are always able to change configuration logic
- Master units M1 and M1S configurable via the MSD (Mosaic Safety Designer) graphic interface (provided with each Master units at no extra cost)
- Simply adding or removing safety function blocks at any stage of machine design
- Is able to check the logic configuration of the application during the designing phase through the **validation function** and **Simulation** as well as to test it during the installation through the **monitor function**
- Allows **tamper-proof system** configurations as:
  - detection of tempering attempts through specific tests (i.e. mandatory test of the safety device at machine start-up)
  - protection against unauthorized changes to the project through a **2-level password**
- All logic is configured through a **graphic interface**. No more laborious wiring is needed as with traditional solutions
- A lower number of electromechanical components also means a **better Performance Level** and, therefore, a **higher Safety Level**
- The project report provides the actual values of  $PFH_d$ ,  $DC_{avg}$  and  $MTTF_d$  according to EN 13849-1 and EN 62061

## M1

### Standard Master Unit

- 8 digital inputs
- 2 inputs for Start/Restart interlock and EDM
- 2 pairs OSSD safety outputs (PNP 400 mA)
- 2 status outputs (PNP 100 mA)
- 4 test outputs (for short-circuits monitoring)

Not compatible with the following expansion units:  
MA4, MI8O4, MO4L



## Connect up to 14 expansions...

### Additional inputs



#### MI8 / MI16 / MI12T8 / MA4

##### Input expansion units

###### MI8

- 8 digital inputs
- 4 test outputs (for short-circuits monitoring)

###### MI16

- 16 digital inputs
- 4 test outputs (for short-circuits monitoring)

###### MI12T8

- 12 digital inputs
- 8 test outputs (for short-circuits monitoring)
- Can manage up to 4 independent safety mats/edges

###### MA4

- 4 independent isolated analogue channels (500 V)
- Each channel can supply 24V DC up to 30 mA
- Each channel can detect a 4-20 mA current or a 0-10V voltage (selectable via software)

### Additional outputs



#### MO2 / MO4 / MO4L HC S8 / MO4L

##### Output expansion units

###### MO2

- 2 pairs OSSD safety outputs (PNP 400 mA)
- 2 inputs for Start/Restart interlock and EDM
- 2 status outputs (PNP 100 mA)

###### MO4

- 4 pairs OSSD safety outputs (PNP 400 mA)
- 4 inputs for Start/Restart interlock and EDM
- 4 status outputs (PNP 100 mA)

###### MO4L HC S8 POWER

- 4 single OSSD safety outputs or 2 pairs (PNP 2,0 A for each channel, total current 8 A)
- 4 inputs for Start/Restart interlock and EDM
- 8 status outputs (PNP 100 mA)

###### MO4L

- 4 single OSSD safety outputs or 2 pairs (PNP 400 mA)
- 4 inputs for Start/Restart interlock and EDM
- 4 status outputs (PNP 100 mA)

### Speed monitoring



#### MV0 / MV1 / MV2

##### Speed monitoring expansion units

Safety speed monitoring (up to PL e)  
for: zero speed control, maximum speed control, speed range control, direction control

###### MV0

Inputs for 2 proximity switches

###### MV1

Inputs for 1 incremental encoder and 2 proximity switches (TTL, HTL o SIN/COS)

###### MV2

Inputs for 2 incremental encoders and 2 proximity switches (TTL, HTL o SIN/COS)



### M1S

#### Enhanced Master Unit

- 8 digital inputs
- 4 inputs for Start/Restart interlock and EDM
- 4 single OSSD safety outputs, or 2 pairs (PNP 400 mA)
- 4 status outputs (PNP 100 mA)
- 4 test outputs (for short-circuits monitoring)

Compatible with all expansion units

## ...to the Master Units

### Safety relays

### Communication

### Additional inputs/outputs

### Additional status outputs



INDUSTRY  
**4.0**  
ready

### MOR4 / MOR4 S8 / MR2 / MR4

Safety relay output expansion units

#### MR2

- 2 safety relays with guided contacts
- 2 NO + 1 NC contacts (250 VAC 6 A)
- 1 NC contacts for EDM feedback

#### MR4

- 4 safety relays with guided contacts
- 4 NO + 2 NC contacts (240 VAC 6 A)
- 2 NC contacts for EDM feedback

#### MOR4

- 4 safety relays with guided contacts
- 4 NO contacts (250 VAC 6 A)
- It is possible to select two different configurations via MSD:
  - 4 independent single channel outputs
  - 2 dual channel outputs
- 4 inputs for Start/Restart interlock and EDM
- Single channel LED signaling

#### MOR4S8

As MOR4, with 8 status outputs (PNP 100 mA)

### MBx

Field-bus interface units

- Profibus DP
- DeviceNET
- CANopen
- EthernetIP
- EtherCAT
- Profinet
- Modbus RTU
- Modbus TCP
- CC-Link
- USB

### MCT

Mosaic bus transfer

Interface unit allowing the connection of remote expansions via proprietary MSC bus

#### MCT1

1 connection interface (1 I/O)

#### MCT2

2 connections interface (2 I/O)

### MI802 / MI804

Input/Output expansion units

#### MI802

- 8 digital inputs
- 2 inputs for Start/Restart interlock and EDM
- 2 pairs OSSD safety outputs (PNP 400 mA)
- 2 status outputs (PNP 100 mA)
- 4 test outputs (for short-circuits monitoring)

#### MI804

- 8 digital inputs
- 4 inputs for Start/Restart interlock and EDM
- 4 single OSSD safety outputs or 2 pairs (PNP 400 mA)
- 4 status outputs (PNP 100 mA)
- 4 test outputs (for short-circuits monitoring)

### MOS8 / MOS16

Status output expansion units

#### MOS8

8 status outputs \* (PNP 100 mA)

#### MOS16

16 status outputs \* (PNP 100 mA)

\* Safety Level of status outputs:  
SIL 1 - SILCL1 - PL c - Cat.1





- DIGITAL INPUTS  
8
- SAFETY OUTPUTS  
2 pairs OSSD
- EDM/RESTART  
2
- TEST OUTPUTS  
4
- STATUS OUTPUTS  
2
- LOGICAL OPERATORS  
64

## APPROVALS

- 2006/42/EC: "Machine Directive"
- 2014/30/EU: "Electromagnetic Compatibility Directive".
- 2014/35/EU: "Low Voltage Directive"
- EN 61496-1:2013 (Type 4) "Safety of machinery - Electro sensitive protective equipment - General requirements and tests"
- EN 61131-2:2007 "Programmable controllers - Part 2. Equipment requirements and tests"
- EN 61508-1:2010 (SIL3) "Functional safety of electrical / electronic / programmable electronic safety related systems - General requirements"
- EN 61508-2:2010 (SIL3) "Functional safety of electrical / electronic / programmable electronic safety related systems - Requirements for electrical/electronic/programmable electronic safety-related systems"
- EN 61508-3:2010 (SIL3) "Functional safety of electrical / electronic / programmable electronic safety related systems: Software requirements"
- EN 61508-4:2010 (SIL3) "Functional safety of electrical / electronic / programmable electronic safety related systems - Definitions and abbreviations"
- IEC 62061:2005/A2:2015 (SILCL 3) "Safety of machinery - Functional safety of safety-related electrical, electronic and programmable electronic control systems"
- EN ISO 13849-1:2008 (Cat. 4 PL e) "Safety of machinery - Safety-related parts of control systems - Part 1: General principles for design"
- IEC 61784-3:2008 "Industrial communication networks - Profiles - Part 3: Functional safety fieldbuses - General rules and profile definitions"
- UNI EN 81-20:2014 "Safety rules for the construction and installation of lifts. Lifts for the transport of persons and goods. Part 20: Passenger and goods passenger lift"
- UNI EN 81-50:2014 "Safety rules for the construction and installation of lifts. Examinations and test. Part 50: Design rules, calculations, examinations and tests of lift components"
- UL (C+US) mark for USA and Canada
- ANSI / UL 1998: "Safety Software in Programmable Components"
- The S-Mark carries the same weight in Korea as the CE-Mark does in Europe

## Certifications



## M1

### STANDARD MASTER UNIT

Master unit, also usable as a stand-alone device, able to control any other expansion unit (not compatible with: MI8O4, MO4L and MA4). With 8 digital inputs and 2 pairs OSSD safety outputs.

### APPLICATION EXAMPLE

**Stand-alone:** To provide protection for a smaller machinery connecting for example 1 safety light curtain, 1 e-stop, 1 magnetic sensor and 1 two-hand switch.

**As Master unit:** To control a more complex system providing protection for bigger machineries.

### TECHNICAL FEATURES

Digital inputs	8 digital inputs
Safety outputs	2 pairs OSSD (PNP 400 mA output current)
EDM	2 inputs for Start/Restart interlock and external device monitoring (EDM)
Status outputs	2 programmable digital signal outputs (PNP 100 mA output current)
Test outputs	4 test outputs for sensor monitoring
LED signalling	Input/output status and fault diagnostics
Configuration	With PC via USB interface using MSD (Mosaic Safety Designer) software
MSC bus connection	With MSC connector (optional)
MCM	Mosaic Configuration Memory (optional)

### ACCESSORIES

**MSC Rear Bus connector:** necessary to connect the Master unit to any expansion unit. As the Master unit can be used as stand-alone, the bus connector must be ordered separately.

**MCM Card (Mosaic Configuration Memory):** memory card designed to store the Master unit configuration as a backup. Can be used to restore the saved configuration onto a new Master unit or to duplicate the current configuration to other Master units.

### PART NUMBERS

Code	Description
1100000	M1 Master unit - Screw terminal blocks
1100002	M1C Master unit - Clamp terminal blocks
1100060	MCM - Memory card
1100061	MSC - Mosaic Safety Communication connector
1100099	MSC-C - Mosaic Safety Communication connector with terminal end cap
1100062	USB configuration cable (A-mini B, length 1,8 m)
1100079	CPM - Polarizing keys for Mosaic connectors



DIGITAL INPUTS  
8

SAFETY OUTPUTS  
4 single OSSD or 2 pairs

EDM/RESTART  
4

TEST OUTPUTS  
4

STATUS OUTPUTS  
4

LOGICAL OPERATORS  
128

## APPROVALS

- 2006/42/EC: "Machine Directive"
- 2014/30/EU: "Electromagnetic Compatibility Directive".
- 2014/35/EU: "Low Voltage Directive"
- EN 61496-1:2013 (Type 4) "Safety of machinery - Electro sensitive protective equipment - General requirements and tests"
- EN 61131-2:2007 "Programmable controllers - Part 2. Equipment requirements and tests"
- EN 61508-1:2010 (SIL3) "Functional safety of electrical / electronic / programmable electronic safety related systems - General requirements"
- EN 61508-2:2010 (SIL3) "Functional safety of electrical / electronic / programmable electronic safety related systems - Requirements for electrical/electronic/programmable electronic safety-related systems"
- EN 61508-3:2010 (SIL3) "Functional safety of electrical / electronic / programmable electronic safety related systems: Software requirements"
- EN 61508-4:2010 (SIL3) "Functional safety of electrical / electronic / programmable electronic safety related systems - Definitions and abbreviations"
- IEC 62061:2005/A2:2015 (SILCL 3) "Safety of machinery - Functional safety of safety-related electrical, electronic and programmable electronic control systems"
- EN ISO 13849-1:2008 (Cat. 4 PL e) "Safety of machinery - Safety-related parts of control systems - Part 1: General principles for design"
- IEC 61784-3:2008 "Industrial communication networks - Profiles - Part 3: Functional safety fieldbuses - General rules and profile definitions"
- UNI EN 81-20:2014 "Safety rules for the construction and installation of lifts. Lifts for the transport of persons and goods. Part 20: Passenger and goods passenger lift"
- UNI EN 81-50:2014 "Safety rules for the construction and installation of lifts. Examinations and test. Part 50: Design rules, calculations, examinations and tests of lift components"
- UL (C+US) mark for USA and Canada
- ANSI / UL 1998: "Safety Software in Programmable Components"

## Certifications

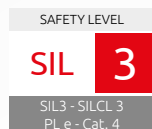

## M1S

### ENHANCED MASTER UNIT

Master unit, also usable as a stand-alone device, able to control any other expansion unit. With 8 digital inputs, 4 single or 2 pairs OSSD safety outputs.

### APPLICATION EXAMPLE

The enhanced version of the master unit allows to control complex system and machinery that require a greater number of safety outputs, status outputs and logical operators

### TECHNICAL FEATURES

Digital inputs	8 digital inputs
Safety outputs	4 single OSSD or 2 pairs (PNP 400 mA output current)
EDM	4 inputs for Start/Restart interlock and external device monitoring (EDM)
Status outputs	4 programmable digital signal outputs (PNP 100 mA output current)
Test outputs	4 test outputs for sensor monitoring
LED signalling	Input/output status and fault diagnostics
Configuration	With PC via USB interface using MSD (Mosaic Safety Designer) software
MSC bus connection	With MSC connector (optional)
MCM	Mosaic Configuration Memory (optional)

### ACCESSORIES

**MSC Rear Bus connector:** necessary to connect the Master unit to any expansion unit. As the Master unit can be used as stand-alone, the bus connector must be ordered separately.

**MCM Card (Mosaic Configuration Memory):** memory card designed to store the Master unit configuration as a backup. Can be used to restore the saved configuration onto a new Master unit or to duplicate the current configuration to other Master units.

### PART NUMBERS

Code	Description
1100003	M1S Master unit - Screw terminal blocks
1100004	M1SC Master unit - Clamp terminal blocks
1100060	MCM - Memory card
1100061	MSC - Mosaic Safety Communication connector
1100099	MSC-C - Mosaic Safety Communication connector with terminal end cap
1100062	USB configuration cable (A-mini B, length 1,8 m)
1100079	CPM - Polarizing keys for Mosaic connectors

## MI8O2 - MI8O4

### INPUT/OUTPUT EXPANSION UNITS

Input/output expansion unit. With 8 digital inputs and 2 (MI8O2) or 4 (MI8O4) OSSD safety outputs. MI8O4 allows to configure the safety output as single channel.

#### APPLICATION EXAMPLE

To provide more inputs and outputs for a smaller machinery connecting for example extra safety sensors and/or e-stops buttons and to control 2 extra actuators.



- DIGITAL INPUTS  
8
  - SAFETY OUTPUTS  
2 pairs OSSD (MI8O2)  
4 single or 2 pairs OSSD (MI8O4)
  - EDM/RESTART  
2 (MI8O2), 4 (MI8O4)
  - TEST OUTPUTS  
4
  - STATUS OUTPUTS  
2 (MI8O2), 4 (MI8O4)
- COMPATIBILITY  
M1 and M1S (MI8O2)  
M1S (MI8O4)

#### TECHNICAL FEATURES

Digital inputs	8 digital inputs
Safety outputs	2 pairs OSSD (MI8O2) 4 single OSSD or 2 pairs (MI8O4) (PNP 400 mA output current)
EDM	2 (MI8O2) or 4 (MI8O4) inputs for Start/Restart interlock and external device monitoring (EDM)
Status outputs	2 (MI8O2) or 4 (MI8O4) programmable digital signal outputs (PNP 100 mA output current)
Test outputs	4 test outputs for sensor monitoring
LED signalling	Input/output status and fault diagnostics
Connection to Master Unit	Via MSC connector (included)

#### PART NUMBERS

Code	Description
1100010	MI8O2 Expansion unit - Screw terminal blocks
1100110	MI8O2C Expansion unit - Clamp terminal blocks
1100011	MI8O4 Expansion unit - Screw terminal blocks
1100111	MI8O4C Expansion unit - Clamp terminal blocks
1100079	CPM - Polarizing keys for Mosaic connectors

## MI8 - MI16

### INPUT EXPANSION UNITS

Input expansion units with 8 (MI8) or 16 (MI16) digital inputs increase the number of inputs of an Master unit.

#### APPLICATION EXAMPLE

To provide more inputs for a smaller machinery connecting for example extra safety sensors and/or e-stops buttons.



- DIGITAL INPUTS  
8 (MI8), 16 (MI16)
  - TEST OUTPUTS  
4
- COMPATIBILITY  
M1 and M1S

#### TECHNICAL FEATURES

Digital inputs	8 digital inputs
Test outputs	4 test outputs for sensor monitoring
LED signalling	Input/output status and fault diagnostics
Connection to Master Unit	Via MSC connector (included)

#### PART NUMBERS

Code	Description
1100020	MI8 Expansion unit - Screw terminal blocks
1100120	MI8C Expansion unit - Clamp terminal blocks
1100021	MI16 Expansion unit - Screw terminal blocks
1100121	MI16C Expansion unit - Clamp terminal blocks
1100079	CPM - Polarizing keys for Mosaic connectors



## MI12T8

### INPUT EXPANSION UNIT

Input expansion unit for safety mats and edges. With 12 digital inputs and 8 test outputs for sensor monitoring.

#### APPLICATION EXAMPLE

With 8 test outputs can manage up to 4 independent safety mats or edges. Test output signals are used to monitor overloads and short circuits on input lines.



DIGITAL INPUTS  
12  
TEST OUTPUTS  
8

COMPATIBILITY  
M1 and M1S

#### TECHNICAL FEATURES

Digital inputs	12 digital inputs
Test outputs	8 test outputs for sensor monitoring
LED signalling	Input/output status and fault diagnostics
Connection to Master Unit	Via MSC connector (included)

#### PART NUMBERS

Code	Description
1100022	MI12T8 Expansion unit - Screw terminal blocks
1100122	MI12T8C Expansion unit - Clamp terminal blocks
1100079	CPM - Polarizing keys for Mosaic connectors

## MA4



### ANALOGUE INPUTS EXPANSION UNIT

With 4 independent isolated analogue channels (500V). Individual channels can be paired-up to allow sensor reading redundancy.

#### APPLICATION EXAMPLE

Any application requiring analogic sensors connection as loading cells, pressure switches, temperature measurements, flow and level measurements, etc.



ANALOGUE INPUTS  
4  
CURRENT DETECTION  
4-20 mA  
VOLTAGE DETECTION  
0-10 V

COMPATIBILITY  
M1S

#### TECHNICAL FEATURES

Analogue inputs detection	Each channel can detect a 4-20 mA current or a 0-10 V voltage (selectable via software)
Analogue inputs power supply	Each channel can supply 24V DC up to 30 mA
LED signalling	Input status and fault diagnostics
Connection to Master Unit	Via MSC connector (included)
Resolution	16 bit
Sampling per second	2,5 SPS ... 4000 SPS selectable
Comparators	Simple with 1 or 2 thresholds

#### PART NUMBERS

Code	Description
1100025	MA4 Expansion unit - Screw terminal blocks
1100125	MA4C Expansion unit - Clamp terminal blocks
1100079	CPM - Polarizing keys for Mosaic connectors

## MO4L HC S8 POWER

### HIGH CURRENT OUTPUT EXPANSION UNIT

Output expansion unit with 2 pairs OSSD or 4 single OSSD high current safety outputs (PNP 2,0 A per channel, 8 A in total), 4 relative inputs for external feedback contacts (EDM) and 8 status output.

#### APPLICATION EXAMPLE

To provide 2 different high current output configurations (configurable with MSD configuration software)

- 4 single OSSD (1 safety output per channel with 4 feedback inputs)
- 2 pairs OSSD (2 safety output per channel with 2 feedback inputs)



SAFETY OUTPUTS  
4 single OSSD or 2 pairs

EDM/RESTART  
4

STATUS OUTPUTS  
8

COMPATIBILITY  
M1 and M1S



#### TECHNICAL FEATURES

Safety outputs	4 single OSSD or 2 pairs (PNP 2 A output current active high)
EDM	4 inputs for Start/Restart interlock and external device monitoring (EDM)
Output current	2 A max per channel (total current 8 A)
Status outputs	8 digital programmable signalling outputs - (PNP 100 mA output current)
LED signalling	Output status and fault diagnostics
Connection to Master Unit	Via MSC connector (included)

#### PART NUMBERS

Code	Description
1100032	MO4LHCS8 Expansion unit - Screw terminal blocks
1100132	MO4LHCS8C Expansion unit - Clamp terminal blocks
1100079	CPM - Polarizing keys for Mosaic connectors

## MO4L



### OUTPUT EXPANSION UNIT

Output expansion unit with 2 pairs OSSD or 4 single OSSD safety outputs (PNP 400 mA), 4 relative inputs for external feedback contacts (EDM) and 4 status output.

#### APPLICATION EXAMPLE

To provide 2 different output configurations (configurable with MSD configuration software)

- 4 single OSSD (1 safety output per channel with 4 feedback inputs)
- 2 pairs OSSD (2 safety output per channel with 2 feedback inputs)



SAFETY OUTPUTS  
4 single OSSD (or 2 pairs)

EDM/RESTART  
4

STATUS OUTPUTS  
4

COMPATIBILITY  
M1S

#### TECHNICAL FEATURES

Safety outputs	4 single OSSD or 2 pairs (PNP 400 mA output current active high)
EDM	4 inputs for Start/Restart interlock and external device monitoring (EDM)
Status outputs	4 digital programmable signalling outputs - (PNP 100 mA output current)
LED signalling	Output status and fault diagnostics
Connection to Master Unit	Via MSC connector (included)

#### PART NUMBERS

Code	Description
1100012	MO4L Expansion unit - Screw terminal blocks
1100212	MO4LC - Expansion unit - Clamp terminal blocks
1100079	CPM - Polarizing keys for Mosaic connectors

## MOR4

### SAFETY RELAY UNIT WITH CONFIGURABLE OUTPUTS

Output expansion unit with 4 configurable safety relays with guided contacts.

#### APPLICATION EXAMPLE

To provide 4 configurable guided contact safety relays. It allows to select the safety category via MSD:

- Safety Cat. 1: 4 independent single channel outputs
- Safety Cat. 2: 4 independent single channel outputs with OTE (Output Test Equipment)
- Safety Cat. 4: 2 independent double channels outputs



SAFETY RELAY  
4

EDM/RESTART  
4

COMPATIBILITY  
M1 and M1S

#### TECHNICAL FEATURES

Safety relays	4 safety relays with 6 A 250 VAC guided contacts
EDM	4 inputs for Start/Restart interlock and external device monitoring (EDM)
LED signalling	Output status and fault diagnostics
Connection to Master Unit	Via MSC connector (included). Do not use Master OSSDs to drive relays

#### PART NUMBERS

Code	Description
1100042	MOR4 Expansion unit - Screw terminal blocks
1100142	MOR4C Expansion unit - Clamp terminal blocks
1100079	CPM - Polarizing keys for Mosaic connectors

## MOR4S8

### SAFETY RELAY WITH CONFIGURABLE OUTPUTS UNITS AND 8 STATUS OUTPUTS

Output expansion units provide 4 configurable safety relays with guided contacts.

#### APPLICATION EXAMPLE

To provide 4 configurable guided contact safety relays. It allows to select the safety category via MSD:

- Safety Cat. 1: 4 independent single channel outputs
- Safety Cat. 2: 4 independent single channel outputs with OTE (Output Test Equipment)
- Safety Cat. 4: 2 independent double channels outputs



SAFETY RELAY  
4

EDM/RESTART  
4

STATUS OUTPUTS  
8

COMPATIBILITY  
M1 and M1S

#### TECHNICAL FEATURES

Safety relays	4 safety relays with 6 A 250 VAC guided contacts
EDM	4 inputs for Start/Restart interlock and external device monitoring (EDM)
LED signalling	Output status and fault diagnostics
Status outputs	8 digital programmable signalling outputs - (PNP 100 mA output current)
Connection to Master Unit	Via MSC connector (included). Do not use Master OSSDs to drive relays

#### PART NUMBERS

Code	Description
1100043	MOR4S8 Expansion unit - Screw terminal blocks
1100143	MOR4S8C Expansion unit - Clamp terminal blocks
1100079	CPM - Polarizing keys for Mosaic connectors

## MR2 - MR4

### SAFETY RELAY UNITS

Output expansion units provide 2 (MR2) or 4 (MR4) safety relays outputs with guided contacts connectable to 2 or 4 independent OSSD pairs. These units can also be used separately from the Mosaic system.

#### APPLICATION EXAMPLE

To provide 2 or 4 guided contact safety relay in applications where there is the need to cut the actuators power supply. Each NO contact is interrupted twice by the integrated safety relays.



SAFETY RELAY  
2 (MR2), 4 (MR4)

COMPATIBILITY  
M1 and M1S

#### TECHNICAL FEATURES

Safety relays	MR2 - 2 safety relays with 6 A 250 VAC guided contacts: 2 NO + 1 NC for EDM feedback
	MR4 - 4 safety relays with 6 A 250 VAC guided contacts: 4 NO + 2 NC for EDM feedback
LED signalling	OSSD output status (input in MRx)
Connection to Master Unit	The MR2 and MR4 expansion units do not require MSC as they are wired directly to the selected OSSD

#### PART NUMBERS

Code	Description
1100040	MR2 Expansion unit - Screw terminal blocks
1100140	MR2C Expansion unit - Clamp terminal blocks
1100041	MR4 Expansion unit - Screw terminal blocks
1100141	MR4C Expansion unit - Clamp terminal blocks
1100079	CPM - Polarizing keys for Mosaic connectors

## MO2 - MO4

### OUTPUT EXPANSION UNITS

Output expansion units with 2 (MO2) or 4 (MO4) safety outputs pairs increase the number of safety outputs of a Master unit.

#### APPLICATION EXAMPLE

To provide more safety outputs in machine where different actuators need to be controlled. For example automatic packaging machines, etc.



SAFETY OUTPUTS  
2 (MO2), 4 (MO4)

EDM/RESTART  
2 (MO2), 4 (MO4)

STATUS OUTPUTS  
2 (MO2), 4 (MO4)

COMPATIBILITY  
M1 and M1S

#### TECHNICAL FEATURES

Safety outputs	MO2 - 2 OSSD pairs (PNP 400 mA output current) MO4 - 4 OSSD pairs (PNP 400 mA output current)
EDM	MO2 - 2 inputs for Start/Restart interlock and external device monitoring (EDM) MO4 - 4 inputs for Start/Restart interlock and external device monitoring (EDM)
Status outputs	MO2 - 2 programmable digital signal outputs - (PNP 100 mA output current) MO4 - 4 programmable digital signal outputs - (PNP 100 mA output current)
LED signalling	Input/output status and fault diagnostics
Connection to Master Unit	Via MSC connector (included)

#### PART NUMBERS

Code	Description
1100030	MO2 Expansion unit - Screw terminal blocks
1100130	MO2C Expansion unit - Clamp terminal blocks
1100031	MO4 Expansion unit - Screw terminal blocks
1100131	MO4C Expansion unit - Clamp terminal blocks
1100079	CPM - Polarizing keys for Mosaic connectors



INPUT MV0 2 Proximities	INPUT MV1 1 Encoder 1 or 2 Proximities	INPUT MV2 1 or 2 Encoders 1 or 2 Proximities
----------------------------	--	--

AXIS MV0 2	AXIS MV1 2	AXIS MV2 2
---------------	---------------	---------------

COMPATIBILITY  
M1 and M1S

COMPATIBILITY  
M1 and M1S

COMPATIBILITY  
M1 and M1S

RJ-45 (1 for MV1, 2 for MV2) connectors for encoders and terminal blocks for proximity switches.

Max. input frequency for encoders: up to 500 KHz (300 KHz for HTL encoder).

Max. input frequency for proximity switches: up to 5 KHz.

The MV2 module includes two configurable logical outputs and is therefore able to control up to two independent axis (configuration via MSD).

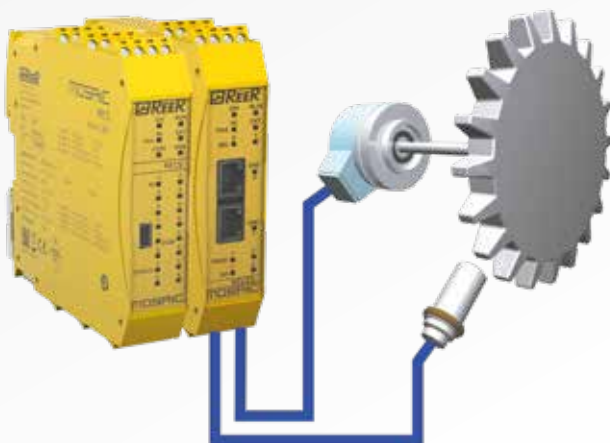

## MV0 - MV1 - MV2

### SAFETY SPEED MONITORING UNITS

Safety speed monitoring (up to PL e) for: zero speed control, max. speed, speed range and direction control.

#### APPLICATION EXAMPLE

Any application requiring speed monitoring for a hazardous tool. See relevant application example on-page 40. Maintenance speed control in rail dependent storage and retrieval equipment applications.

#### TECHNICAL FEATURES

Digital inputs	MV0 - Input for 2 PNP/NPN proximity switches MV1 - Input for 1 incremental encoder (TTL, HTL or SIN/COS) and 1 or 2 PNP/NPN proximity switches MV2 - Input for 1 or 2 incremental encoder (TTL, HTL or SIN/COS) and 1 or 2 PNP/NPN proximity switches
Speed thresholds	Up to 8 logically selectable speed thresholds (freely configurable via MSD) for each logical output (axis)
LED signalling	Input/output status and fault diagnostics
Connection to Master Unit	Via MSC connector (included)

#### ACCESSORIES

SAFECODER - Safety Sin/Cos incremental encoder.  
See page 15

MCCV - Speed monitoring sniffer cable.  
See page 20

#### PART NUMBERS

Code	Description
1100077	MV0 - Proximities switch expansion module
1100070	MV1T - 1 TTL incremental encoder + 1 or 2 PNP/NPN proximity switches expansion module
1100086	MV1TB - 1 TTL incremental encoder (24 VDC) + 1 or 2 PNP/NPN proximity switches expansion module
1100071	MV1H - 1 HTL incremental encoder + 1 or 2 PNP/NPN proximity switches expansion module
1100072	MV1S - 1 SIN/COS incremental encoder + 1 or 2 PNP/NPN proximity switches expansion module
1100073	MV2T - 1 or 2 TTL incremental encoders + 1 or 2 PNP/NPN proximity switches expansion module
1100087	MV2TB - 1 or 2 TTL incremental encoders (24 VDC) + 1 or 2 PNP/NPN proximity switches expansion module
1100074	MV2H - 1 or 2 HTL incremental encoders + 1 or 2 PNP/NPN proximity switches expansion module
1100076	MV2S - 1 or 2 SIN/COS incremental encoders + 1 or 2 PNP/NPN proximity switches expansion module
1100079	CPM - Polarizing keys for Mosaic controller connectors

## MCT1 - MCT2

### REMOTE INTERFACE UNITS

Interface module allowing the connection of remote expansions units via the MSC bus.

#### APPLICATION EXAMPLE

Ideal solution for the interconnection of the safety functions of more machineries on a single production line.



CONNECTIONS

- 1 (MCT1)
- 2 (MCT2)

COMPATIBILITY  
M1 and M1S

#### TECHNICAL FEATURES

Connections	MCT1 - 1 connection: 1 input or 1 output to be placed at the beginning or at the end of the network MCT2 - 2 connections: 1 input and 1 output
Cable	Shielded RS 485 serial interface compatible cable (4 wires + shield) via the connector block. We recommend the use of Reer's MCTx cables for a correct operation of the system
Total distance	Up to 50 m for each connection (total distance up to 250 m). Max. 5 MCT expansions units
LED signalling	Module status and fault diagnostics
Connection to Master Unit	Via MSC connector (included)

#### PART NUMBERS

Code	Description
1100058	MCT1 Expansion unit
1100057	MCT2 Expansion unit
1100063	MCT25 - Serial cable for MSC bus transfer 25 m
1100064	MCT50 - Serial cable for MSC bus transfer 50 m
1100065	MCT100 - Serial cable for MSC bus transfer 100 m

## HM1

### DISPLAY UNIT

Alphanumeric display. It displays the messages programmed using the HSD software.



#### APPLICATION EXAMPLE

Used in control panels to display status messages as diagnostic or operation functions of the safety system. Can be also used to display other functioning messages of the machine or the plant.

#### TECHNICAL FEATURES

Display	Green display LCD 2x16
Ports	2 configurable RS 485 serial ports USB port for messages on display programming
Inputs	4 inputs for the connection with Mosaic: 2 synchronous serial ports (clock + data) or 4 asynchronous serial ports (data)

HM1 can be connected to Mosaic in 3 ways:

Wired to a status output connected to the serial operator, asynchronous serial connection  
Max 32 status displayed.

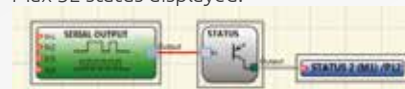

Wired to 2 status outputs connected to the serial operator, synchronous serial connection  
Max 16 status displayed.

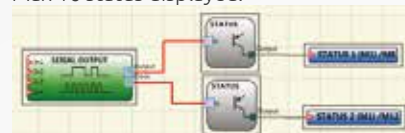

Wired to the serial MBx module via RS 485 serial port, all I/O statuses and diagnostic displayed.

#### PART NUMBERS

Code	Description
1100090	HM1 Expansion unit
1100062	USB cable A-mini B, length 1,8 m

## MBx

### FIELD-BUS INTERFACE UNITS

Expansion unit for connection to the most common industrial Field-bus systems for diagnostics and data communication.

#### APPLICATION EXAMPLE

In all applications where it is required to communicate between the machine's safety system and the PLC control.



- MBP - Profibus DP
- MBD - DeviceNET
- MBC - CANopen
- MBEC - EtherCAT
- MBEI - Ethernet IP
- MBEP - PROFINET
- MBU - Universal Serial Bus
- MBMR - ModBus RTU
- MBEM - ModBus TCP
- MBCCL - CC-Link

**COMPATIBILITY**  
M1 and M1S

#### TECHNICAL FEATURES

**Ports** RS 485 serial ports for I/O Bus expansion  
USB port for configuration

**Connection to Master Unit** Via MSC connector (included)

#### PART NUMBERS

Code	Description
1100050	MBP Profibus DP expansion module
1100051	MBD DeviceNET expansion module
1100052	MBC CANopen expansion module
1100053	MBEC EtherCAT expansion module *
1100054	MBEI EtherNET/IP expansion module *
1100055	MBEP PROFINET expansion module
1100056	MBU Universal Serial Bus expansion module
1100059	MBCCL CC-link expansion module *
1100082	MBMR Modbus RTU expansion module
1100083	MBEM Modbus TCP expansion module *

\* All Ethernet modules have a double RJ45 port

## MOS8 - MOS16

### STATUS OUTPUTS EXPANSION UNITS

Status outputs expansion units for the automation process with safety level: SIL 1 - SILCL 1 - PL c - Cat. 1

#### APPLICATION EXAMPLE

Modules for automation process where status outputs are required. With these units, Mosaic controller can also be used as a PLC for automation.



**SAFETY LEVEL**

**SIL 1**

SIL 1 - SILCL 1  
PL c - Cat. 1

**new**

**STATUS OUTPUTS**  
8 (MOS8)  
16 (MOS16)

**COMPATIBILITY**  
M1 and M1S

#### TECHNICAL FEATURES

**Status outputs** MOS8 - 8 programmable digital status outputs (PNP 100 mA output current)

MOS16 - 16 programmable digital status outputs (PNP 100 mA output current)

**LED signalling** Output status and fault diagnostics

**Connection to Master Unit** Via MSC connector (included)

#### PART NUMBERS

Code	Description
1100091	MOS8 Expansion unit
1100092	MOS16 Expansion unit

# TECHNICAL FEATURES SUMMARY

## MAXIMUM SYSTEM CAPABILITIES: M1 VS M1S

Main unit	M1	M1S	Note
Maximum number of expansion units	14	14	
USB port	yes	yes	
MCM card slot	yes	yes	
Connection with MSC bus	yes	yes	
MSC connector provided	no	no	
Digital inputs	128	128	
Start/Restart inputs and External Device Monitoring	16	32	
Fieldbus input	8	32	The M1S main unit uses a new "footprint map" for data exchange with the fieldbus units
Analogue inputs	-	16	M1S system only
Safety outputs (OSSD)	16	32	The M1S main unit provides 4 single (or 2 pairs) OSSD safety outputs
Programmable status outputs	32	48	The status outputs of the M1S main unit, MI804 and MO4L expansion units can be converted to feedback inputs (up to 4 feedback inputs for the 4 single OSSD safety outputs)  The status outputs of the MOS8 and MOS16 expansion units can reach the safety level: SIL 1 - SILCL 1 - PL c - Cat. 1.
Maximum number of operators managed by the MSD software	64	128	
Maximum number of managed timers	32	48	
Maximum number of "Muting" operators	4	8	
Maximum number of operators "Safety Guard Lock"	4	8	
Maximum number of "Fieldbus Probe" outputs	16	32	

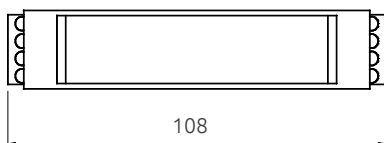
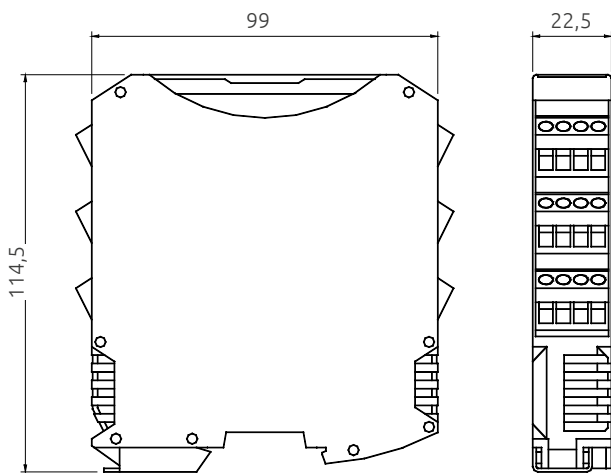

Dimensioni in mm

## MECHANICAL CHARACTERISTICS

- Compact design: single module dimensions 22.5 x 99 x 114.5 mm
- ReeR MSC rear bus connector for connection with other expansion modules
- Operating temperature: -10 ... +55 °C
- Storage temperature: -20 ... +85 °C
- Protection rating: IP20 for housing, IP 2X for terminal block
- Rail fastening according to EN 50022-35 standard
- Removable terminal blocks with screw or clamp contacts (24 x 22.5 mm)



Screw contacts



Clamp contacts



## EXPANSION UNITS TECHNICAL FEATURES

Units	M1802 M1804	M18 MI16	MI12T8	MA4	MO2 MO4	MO4LHCS8	MO4L	MR2 MR4	MCT1 MCT2	MOR4 MOR4S8	MV	MOS8 MOS16	MBx	
Description	Input/ Output units	Input units		Ana- logue input unit	Output units	High Current Safety Outputs units	Safety Outputs units	Guided contact relay output units	Remote interface units	Safety relay configurable output units	Safety speed monito- ring units	Automa- tion units	Field bus units	
USB	-	-	-	-	-	-	-	-	-	-	-	-	yes	
MCM card slot	-	-	-	-	-	-	-	-	-	-	-	-	-	
Connection with MSC bus	yes	yes	yes	yes	yes	yes	yes	-	yes	yes	yes	yes	yes	
MSC connector provided	yes	yes	yes	yes	yes	yes	yes	-	yes	yes	yes	yes	yes	
Safety level	SIL 3 – SILCL 3 according to IEC 61508 - IEC 62061 / PL e – Cat. 4 according to ISO 13849-1											-	-	
Safety inputs	8	8 - 16	12	-	-	-	-	-	-	-	-	2 - 4	-	
Analogue inputs	-	-	-	8	-	-	-	-	-	-	-	-	-	
Safety outputs (OSSD)	2 pairs (M1802) PNP 400 mA 4 single or 2 pairs (M1804) PNP 400 mA	-	-	-	2 pairs (MO2) 4 pairs (MO4) PNP 400 mA	4 single or 2 pairs PNP 2 A max	4 single or 2 pairs PNP 400 mA max	-	-	-	-	-	-	-
Programmable status outputs	2 (M1802) 4 (M1804) PNP 100 mA	-	-	-	2 (MO2) 4 (MO4) PNP 100 mA	8 PNP 100 mA	4 PNP 100 mA	-	-	MOR4S8 8 PNP 100 mA	-	8 - 16 PNP 100 mA (Note)	-	
Test outputs	4	4	8	-	-	-	-	-	-	-	-	-	-	
Safety relay outputs	-	-	-	-	-	-	-	2 NO + 1 NC 4 NO + 2 NC 6 A 250 VAC	-	4 NO single 6 A 250 VAC or 2 NO pairs 6 A 250 VAC	-	-	-	
Start/Restart inputs and External Device Monitoring	2 (M1802) 4 (M1804)	-	-	-	2 (MO2) 4 (MO4)	4	4	-	-	4	-	-	-	
LED signalling	Input/output status and fault diagnostics							Output status			Input status and fault diag.	Output status and fault diag.	Fault diag.	
Power supply (VDC)	24 ± 20%													
Connections	Removable terminal blocks, screw or clamp contacts													
Operating temperature	-10 ... +55 °C													
Storage temperature	-20 ... +85 °C													
Protection rating	IP20 for housing / IP 2X for terminal block													
Fastening	Rail fastening according to EN 50022-35 standard													
Dimension HxWxD (mm)	99 x 22,5 x 114,5													

NOTE: The status outputs of the MOS8 and MOS16 expansion units can reach the safety level:  
SIL 1 - SILCL 1 - PL c - Cat. 1



Shaft version



Hollow shaft version

# SAFECODER

Safety Sin/Cos incremental encoder. Together with Mosaic, it forms a SIL 3 certified safety function for speed monitoring. Available in two models: Shaft or Hollow shaft.

## APPLICATION EXAMPLE

Any applications requiring speed monitoring of a rotating axis. See the application example on page 34.

Features a robust and reliable interface and the ability to handle high mechanical loads.

## TECHNICAL FEATURES

Shaft type	Hollow shaft version Ø 12 mm Shaft version Ø 10 mm with flat surface
Fastening	Safety-Lock™ Allow high rotational speed and high shaft load capacity
Protection rate	Housing and flange side IP67, shaft IP65 (optional IP67)
Immunity to interference	Shock and vibration resistant Insensitive to strong magnetic fields
Resolution	2048 pulse rate
Power supply	SC3 24D2048R - 24 VDC SC3 05D2048R - 5 VDC SC3 24B2048R - 24 VDC SC3 05B2048R - 5 VDC
Connector	Radial M12 8-pole

## APPROVALS

- 2006/42/EC "Machinery Directive"
- 2004/108/EC "Electromagnetic Compatibility (EMC)"
- EN ISO 13849-1 "Safety of machinery: Safety-related parts of control systems. Part 1: General principles for design"
- EN ISO 13849-2 "Safety of machinery: Safety-related parts of control systems. Part 2: Validation"
- IEC 61508 "Functional safety of electrical, electronic and programmable electronic safety-related systems"
- EN ISO 61800-5-2 "Adjustable speed electrical power drive systems". Part 5-2 Safety requirements - Functional
- UL (C+US) mark for USA and Canada
- BGIA - Institute for Occupational Safety and Health - Germany

## Certifications

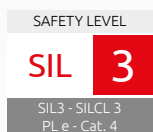

## CONNECTORS

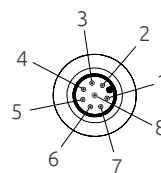

M12 8-pole

- 1 - GND
- 2 - + V
- 3 - A: Sine output
- 4 -  $\bar{A}$ : Sine output
- 5 - B: Cosine output
- 6 -  $\bar{B}$ : Cosine output
- 7 - N.C.
- 8 - N.C.
- shield - PE

## PART NUMBERS

Code	Description
1100102	SC3 24D2048R - 24 V Hollow Shaft version Ø 12 mm
1100103	SC3 05D2048R - 5 V Hollow Shaft version Ø 12 mm
1100104	SC3 24B2048R - 24 V Shaft version Ø 10 mm with flat surface
1100105	SC3 05B2048R - 5 V Shaft version Ø 10 mm with flat surface

## CABLES NEEDED

### C8D x SH

M12 straight connector, 8 poles, shielded cable

Model	Code	Description
C8D 5 SH	1330930	Pre-wired shielded cable 5 m
C8D 10 SH	1330931	Pre-wired shielded cable 10 m
C8D 15 SH	1330932	Pre-wired shielded cable 15 m

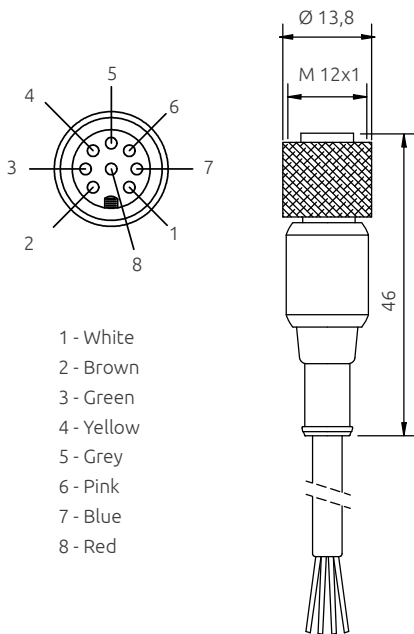

NOTE: cables supplied with M12 8-pole connector at one end only. The other side must be cut off at correct length and crimped with RJ45 connector (not included).

### C8D 9x SH

M12 90° angled connector, 8 poles, shielded cable

Model	Code	Description
C8D 95 SH	1330933	Pre-wired shielded cable 5 m
C8D 910 SH	1330934	Pre-wired shielded cable 10 m
C8D 915 SH	1330935	Pre-wired shielded cable 15 m

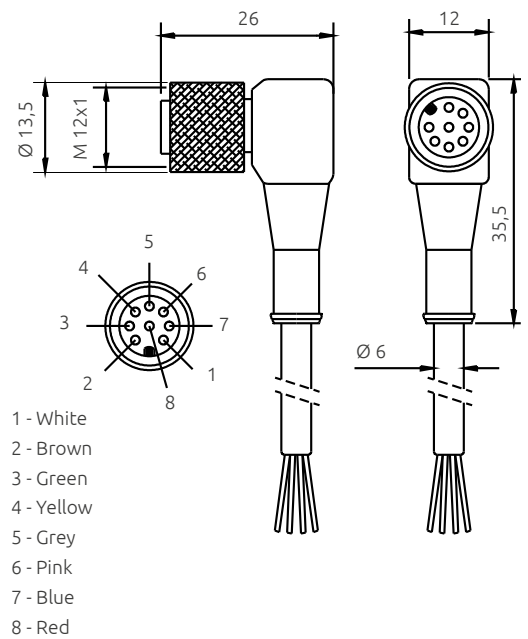

## MECHANICAL DATA

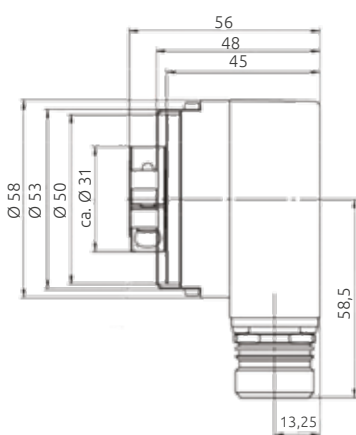

Shaft version with flat surface

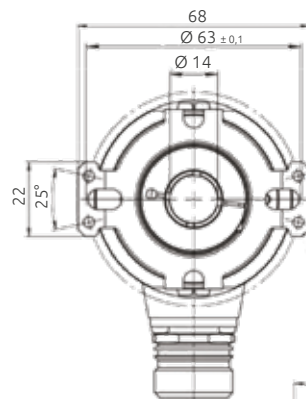

Hollow shaft version

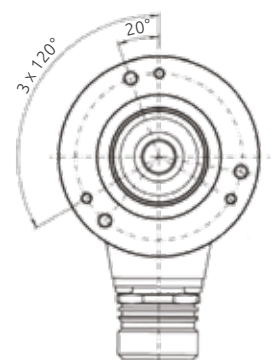
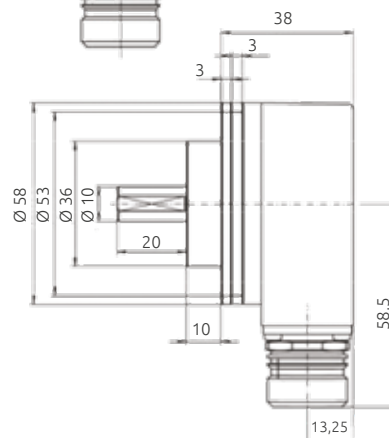

Dimensions: mm

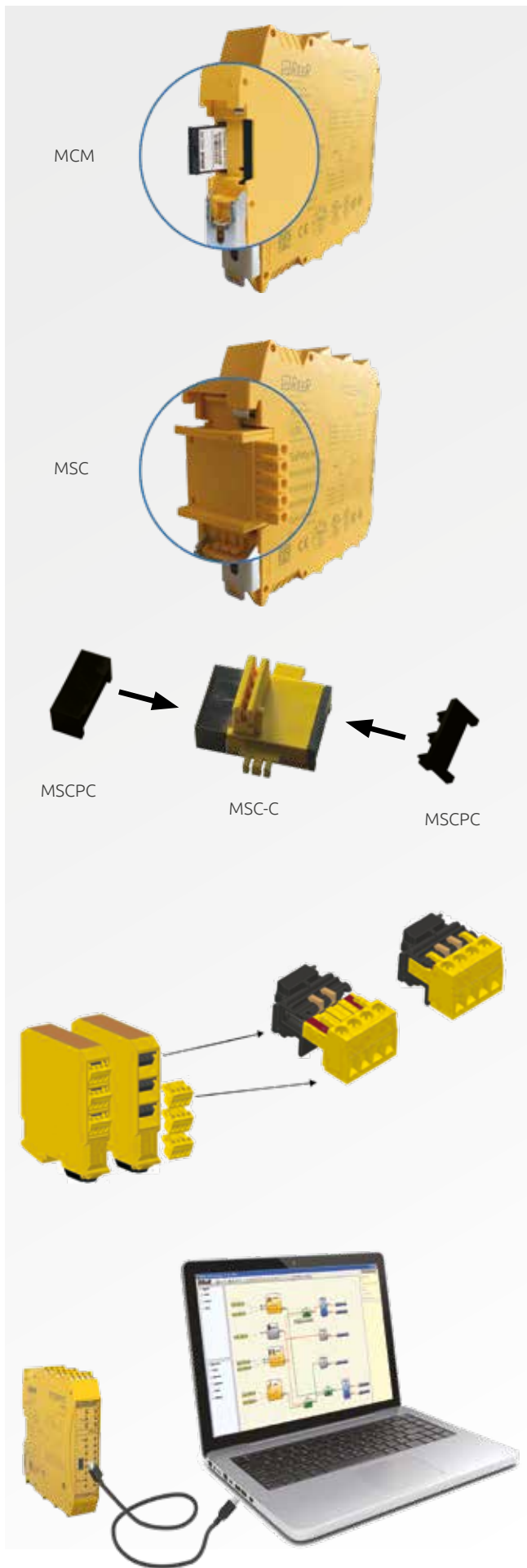

## MCM

### MOSAIC CONFIGURATION MEMORY

Models	Ordering codes	Description
MCM	1100060	Mosaic Configuration Memory – Memory Card

## MSC

### MOSAIC SAFETY COMMUNICATION

Models	Ordering codes	Description
MSC	1100061	Mosaic Safety Communication – Connector
MSC-C	1100099	Mosaic Safety Communication – Connector with terminal end caps (MSCPC)
MSCPC	1100095	Set of 10 Mosaic terminal end caps

## CPM

### POLARIZING KEYS

Models	Ordering codes	Description
CPM	1100079	Polarizing keys for Mosaic controller connectors

## CSU

### CONFIGURATION CABLE

Models	Ordering codes	Description
CSU	1100062	USB A cable – Mini B, lenght 1,8 m



## MTB

### SET OF SCREW TERMINAL BLOCKS

Models	Ordering codes	Description
MTB - Y	1100044	Set of 6 numbered screw terminal blocks (yellow)
MTB - B	1100045	Set of 6 numbered screw terminal blocks (black)

## MTBC

### SET OF CLAMP TERMINAL BLOCKS

Models	Ordering codes	Description
MTBC - Y	1100046	Set of 6 numbered clamp terminal blocks (yellow)
MTBC - B	1100047	Set of 6 numbered clamp terminal blocks (black)

## MCT

### SERIAL CABLE FOR MSC BUS TRANSFER

Models	Ordering codes	Description
MC10	1100113	MCT serial cable for MSC bus transfer 10 m
MC25	1100063	MCT serial cable for MSC bus transfer 25 m
MC50	1100064	MCT serial cable for MSC bus transfer 50 m
MC100	1100065	MCT serial cable for MSC bus transfer 100 m

## MPD

### PULL-DOWN ADAPTER

Models	Ordering codes	Description
MPD	1350150	Pull-down resistor
Each kit contains 2 adapters		

## MCCV

### SNIFFER CABLE

Models	Ordering codes	Description
MCCV 15P 3F 1.0	1100069	Sniffer Cable (splitter D-Sub 15-pole / RJ45) 1000 mm for safety speed monitoring MV modules
MCCV 15P 3F 1.4	1100067	Sniffer Cable (splitter D-Sub 15-pole / RJ45) 1400 mm for safety speed monitoring MV modules
MCCV 15P 3F 1.8	1100048	Sniffer Cable (splitter D-Sub 15-pole / RJ45) 1800 mm for safety speed monitoring MV modules
MCCV 25P 2F 2.5	1100068	Sniffer Cable (splitter D-Sub 25-pole / RJ45) 2500 mm for safety speed monitoring MV modules

# CONFIGURATION SOFTWARE

Every Master Unit comes with a complementary copy of the MSD designer software. The Master Unit configuration is done via USB connection.

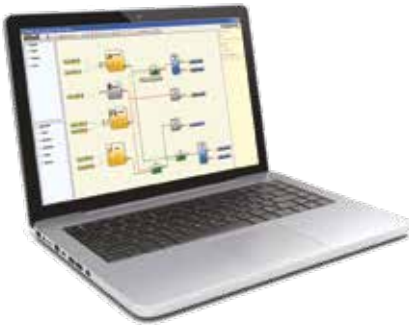

Download the MSD software from [www.reersafety.com/download/mosaic](http://www.reersafety.com/download/mosaic)

- Drag&Drop functionality
- User-frendly
- Real-time I/O monitoring
- Simulation function
- Functional project validation
- Security password - 2-level passwords management for the prevention of unauthorised accesses and therefore of incidental modifications or tampering of the system configuration
- Reports and log files - Log File with project date of creation and related checksum (CRC 4-digit hexadecimal identification) is stored in the Main unit
- Project information - Project report with the following information: project name, configuration, safety information (PFHd, MTTFd, DCavg, resources used)



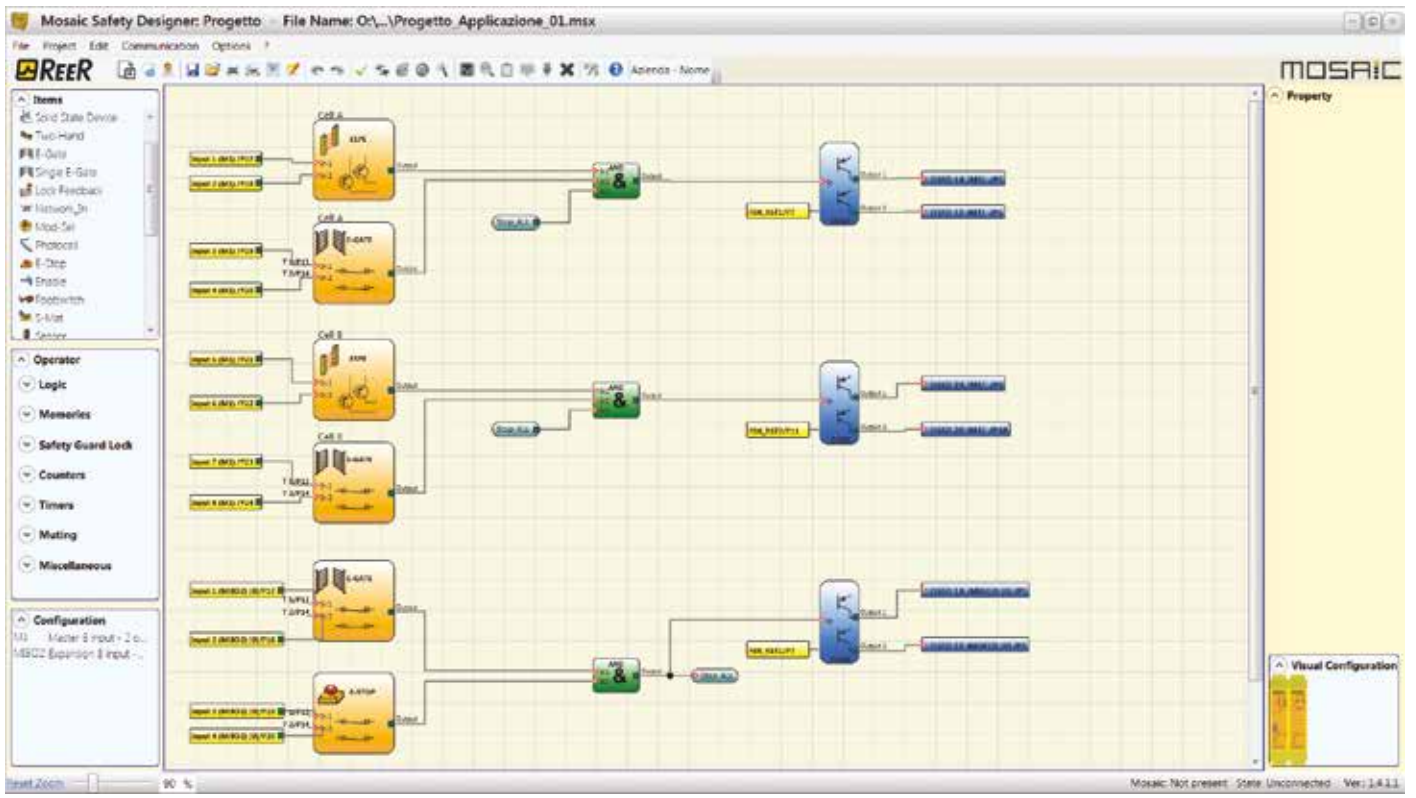





MSD configuration software desktop.

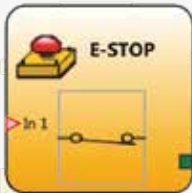
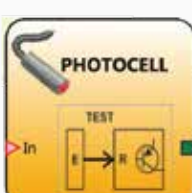
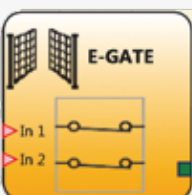
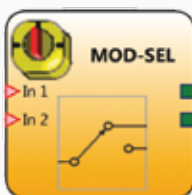

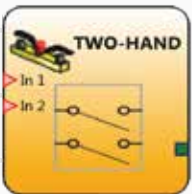
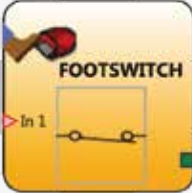
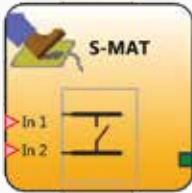
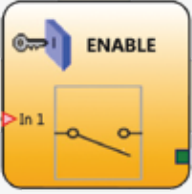

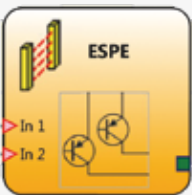
Mosaic Safety Designer MSD

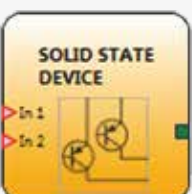
## MAIN FUNCTIONAL BLOCKS

### Input objects

	<p><b>E-stop (emergency stop)</b></p> <p>Configurable for: 1 NC or 2 NC inputs.</p>		<p><b>Photocell (Type 2 safety photocell)</b></p> <p>Input for photocells that need external controller. Specific output test is required.</p>
	<p><b>Single E-gate (safety gate device)</b> <b>E-gate (safety gate device)</b></p> <p>Configurable for: 2 NC or 1 NC + 1NO inputs.</p> <p>More info: "Property window" on page 29.</p>		<p><b>Mod-Sel (safety selector)</b></p> <p>Configurable for: 2, 3 or 4 position selectors inputs. Specific output test is not required.</p>
	<p><b>Testable Safety Device</b> (for any type of electromechanical sensors)</p> <p>Configurable for: 1 NC, 1 NO, 2 NC or 1 NC + 1 NO inputs.</p>		<p><b>Two-Hand (bi-manual control)</b></p> <p>Configurable for: 2 NO (EN 574 III A) or 2 NO + 2 NC (EN 574 III C) inputs.</p>
	<p><b>Footswitch (safety pedal)</b></p> <p>Configurable for: 1 NC, 1 NO, 2 NC or 1 NO + 1 NC inputs.</p>		<p><b>S-Mat (safety mat or safety edge)</b></p> <p>4 wires technology. 2 inputs Specific output test is required on 2 wires.</p>
	<p><b>Enable (enable key)</b></p> <p>Configurable for: 1 NO or 2 NO inputs.</p>		<p><b>Enable Grip Switch</b></p> <p>Configurable for 2 NC or 2 NO + 1 NC inputs.</p>
	<p><b>ESPE (optoelectronic safety light curtain / laser scanner)</b></p> <p>Safety optoelectronics sensors with static OSSD, self-controlled output Dual channel inputs.</p> <p>More info: "Automatic or Manual Reset" on page 29.</p>		<p><b>Lock Feedback</b></p> <p>It verifies the lock status of the Guard Lock device for mobile guard or safety gate. <a href="#">More info: Guard Lock operator on page 32.</a></p> <p>In the case where the inputs indicate that the guard is locked the Output will be 1 (TRUE). Otherwise the output is 0 (FALSE).</p>
	<p><b>Solid State Device</b></p> <p>Generic safety sensors with static OSSD self-controlled outputs Dual channel inputs.</p>		<p><b>Network_In</b></p> <p>This input must be used in case of connection between Mosaic OSSD output and the input of another Mosaic to realize a network. <a href="#">More info: "Network_In" on page 29.</a></p>

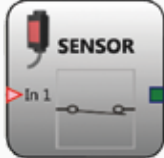
## Input objects

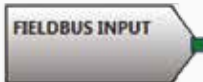
	<p><b>Switch</b></p> <p>Input for non safety switches or non safety signals. E.g.: restart button, position switch, enable signals etc.</p>		<p><b>Sensor</b></p> <p>Input for non safety sensors or non safety signals. E.g.: Muting sensors, enable signals etc.</p>
	<p><b>Fixed Input</b></p> <p>Input fixed to logic level 0 (Low) Input fixed to logic level 1 (High).</p>		<p><b>Fieldbus Input</b></p> <p>Allows to receive signals (up to 8 bits) from the machine control unit via the field-bus module. The signal is connected directly into the diagrams without using any input block. <b>Warning:</b> FIELDBUS inputs are not a safety signals.</p>





## Analog inputs

	<p><b>Analog input</b></p> <p>Analog input functional blocks (4... 20 mA or 0 ... 10 V). This input can be configured as either single or double.</p> <p>More info: <a href="#">on page 32.</a></p> <p>Available with M1S and MA4.</p>
--	--



## Analog operators





	<p><b>Analog Comparison</b></p> <p>This operator verifies that two analogue inputs are equal within a selectable value. The output Q will be 1 (TRUE) when the condition is verified. In the event that the two signals are different, the output will be 0 (FALSE).</p>	 <p><b>Adder</b></p> <p>This operator performs the addition or the difference between the virtual analogue signals coming from an analogue functional block. The number of signals that can be added is from 2 to 8. Choosing to execute the addition and selecting the Arithmetic Average box the result of this operator will be the arithmetic average of the various inputs.</p>
	<p><b>Analog Comparator</b></p> <p>This operator inserts a comparator linked to the analogue output to which it is connected. The threshold value to be inserted will be in engineering units (e.g. Kg, ° C) and must be within the limits defined in the functional block to which it is connected. If the input value is lower than the threshold value, the output Q will be 0 (FALSE). It will be at level 1 (TRUE) if the input value to the operator is greater than or equal to the set threshold value.</p>	

## Speed monitoring objects

	<p><b>Stand Still</b></p> <p>Check that the speed is zero or not greater than the values set.</p>		<p><b>Stand Still and Speed Control</b></p> <p>Check that the speed does not exceed the values set for both the max. speed and zero speed.</p>
	<p><b>Speed Control</b></p> <p>Check that the speed is not greater than the values set.</p>		<p><b>Window Speed Control</b></p> <p>Check that the speed is not lower or higher than the values set.</p>

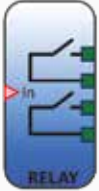

Output objects

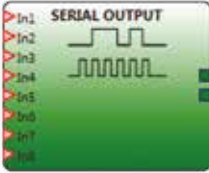
	<p><b>OSSD (safety outputs)</b> PNP safety static outputs (dual channel, 400 mA). The 2 outputs cannot operate independently.</p>		<p><b>Relay</b> The Output relay is a NO relay output. Relay outputs are closed when the input is equal to 1 (TRUE), otherwise they are open (FALSE).</p>
	<p><b>Single OSSD (safety outputs)</b> PNP safety static outputs (single channel, 400 mA). The outputs can operate independently. Available with M1S, MI8O4 and MO4LHCS8 units.</p>		<p><b>Status (signal output)</b> PNP static outputs (single channel, 100 mA). Can be connected to any point in the project.</p>
	<p><b>Fieldbus Probe Output</b> Allows to send signals (up to 16 bits) to the machine control unit via the field-bus module. The signal is connected directly into the diagrams without using any output block.</p>		<p><b>Serial Output</b> It makes possible the transmission of information status to a PLC or HM1 without the need to use fieldbus modules. The Serial Output operator outputs the status of up to 8 inputs, serializing the information. Max. number of operators: 4 - total 32 information status. The serial line can be: Synchronous (1 clock + 1 data output) Asynchronous (1 Manchester coding data output). For a typical application sample, see HM1 on page 14.</p>



Comments







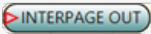

Comments and Title

Add comments to your projects and sign it with a dedicated title box.

Interpage operator

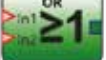
 	<p><b>Interpage</b> The operator Interpage is used to connect parts of the diagram without trace physically the linking. Simply assign the same link identifier operators to Interpage In and Interpage out. Operators Interpage that allow connection of parts of the diagram only by assigning a name to the connection identifier. More info: "Interpage operators" on page 33.</p>
--	--



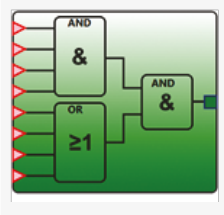

Logical operators - Up to 64 (M1) or 128 (M1S) logical operator can be used

	<p><b>AND</b></p> <p>Logical AND returns an output of 1 (TRUE) if all the inputs are 1 (TRUE).</p>		<p><b>NAND</b></p> <p>Logical NAND returns an output of 0 (FALSE) if all the inputs are 1 (TRUE).</p>
	<p><b>NOT</b></p> <p>Logical NOT inverts the logical status of the input.</p>		<p><b>OR</b></p> <p>Logical OR returns an output of 1 (TRUE) if at least one of the inputs is 1 (TRUE).</p>
	<p><b>NOR</b></p> <p>Logical NOR returns an output of 0 (FALSE) if at least one of the inputs is 1 (TRUE).</p>		<p><b>XOR</b></p> <p>Logical XOR returns an output 0 (FALSE) if the input's number at 1 (TRUE) is even or the inputs are all 0 (FALSE).</p>
	<p><b>XNOR</b></p> <p>Logical XNOR returns an output 1 (TRUE) if the input's number at 1 (TRUE) is even or the inputs are all 0 (FALSE).</p>		<p><b>Multiplexer</b></p> <p>Logical Multiplexer forwards the signal of the inputs to the output according to the SEL selection. If the SEL1÷SEL4 have only one bit set, the selected In n is connected to the Output.</p> <p>If the SEL inputs are:          more than one = 1 (TRUE)          none = 1 (TRUE).</p> <p>The output is set to 0 (FALSE) independently from the In n values.</p>







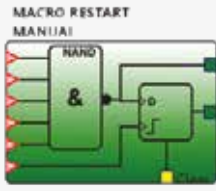
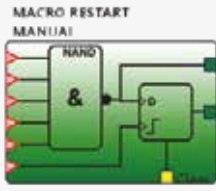
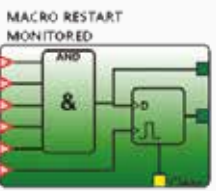

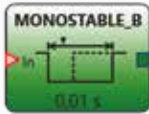

**Logical Macro**  
 Groupings can be created with a maximum of three operators of different types for a total of max. 8 inputs.  
 This allows to increase the maximum number of operators used.

Memory operators

	<p><b>D Flip-Flop</b></p> <p>The D Flip-Flop operator saves the previously set status on output Q.</p>		<p><b>User Restart Manual</b></p> <p>The User Restart Manual operator saves the restart signal according to the Inputs: In, Rising edge input and Clear.</p>
	<p><b>SR Flip-Flop</b></p> <p>SR Flip-Flop operator brings output Q at 1 with Set, 0 with Reset.</p>		<p><b>User Restart Monitored</b></p> <p>The User Restart Monitored operator is used to save the restart signal according to the inputs.</p>
	<p><b>T Flip-Flop</b></p> <p>This operator switches the Q output at each rising edge of the T input (Toggle).</p>		<p><b>Macro Restart Manual</b></p> <p>Used to combine a logic gate chosen by the user with the Restart Manual functional block User Restart Manual.</p>
	<p><b>Macro Restart Monitored</b></p> <p>Used to combine a logic gate chosen by the user with the Restart Manual functional block User Restart Monitored.</p>		<p><b>Macro Restart Monitored</b></p> <p>Used to combine a logic gate chosen by the user with the Restart Manual functional block User Restart Monitored.</p>

Timer operators

	<p><b>Monostable</b></p> <p>The Monostable operator generates a level 1 (TRUE) output activated by the rising edge of the input and remains in this condition for the set time</p>		<p><b>Monostable B</b></p> <p>This operator generates a level 1 (TRUE) output activated by the rising/falling edge of the input and remains in this condition for the set time</p>
	<p><b>Passing Make Contact</b></p> <p>In the Passing Make Contact operator the output follows the signal on the input. However, if this is 1 (TRUE) for longer than the set time, the output changes to 0 (FALSE). When there is an input falling edge, the timer is cleared.</p>		<p><b>Clocking</b></p> <p>This operator has up to 7 inputs to control the output Duty Cycle. Related to the selected input, this operator will generate a clock with different duty cycle. It can be used, for example, to pass or receive the status information to or from a PLC</p> <p><a href="#">More info: "Clocking operator" on page 30.</a></p>
	<p><b>Delay</b></p> <p>Delay operator applies a delay to a signal by setting the output to 1 (TRUE) after the set time, against a change in the level of the input signal.</p>		<p><b>Long delay</b></p> <p>This operator allows to apply a delay (up to 15 hours) to a signal by setting the output to 1 (TRUE) after the set time, against a change in the level of the input signal</p> <p>Available with M1S.</p>
	<p><b>Delay line</b></p> <p>When the signal IN is moved to 0 logic level, this operator inserts a delay to a signal carrying the output OUT to 0 after the time set. If before the end of the set time the input IN returns to 1, the output OUT still generates a pulse signal with this duration: about 2 times the response time plus the delayed time set.</p> <p>Differences with delay: delay Line operator does not filter any input interruptions less than the set time.</p>		<p><b>Long delay line</b></p> <p>When the signal IN is moved to 0 logic level, this operator inserts a delay (up to 15 hours) to a signal carrying the output OUT to 0 after the time set. If before the end of the set time the input IN returns to 1, the output OUT still generates a pulse signal with this duration: about 2 times the response time plus the delayed time set.</p> <p>Differences with delay: long delay Line operator does not filter any input interruptions less than the set time.</p> <p>Available with M1S.</p>
	<p><b>Delay Comparator</b></p> <p>This operator allows to compare the value of the Long delay timer with the set threshold value. The output will be kept to 0 (FALSE) until the timer value is lower than the threshold value. The output will be set to 1 (TRUE) for timer values equal to or greater than the threshold value.</p> <p>Warning: the Delay Comparator operator can only be connected to an output of a Long delay operator.</p> <p>Available with M1S.</p>		

Pre-reset operator

	<p><b>Pre-reset</b></p> <p>This operator allows to memorize the status of the input signal following the correct sequence of the two PreReset and Reset signals: transaction (0-1-0) of the PreReset signal followed (within the set time) by the transition (0-1-0) of the Reset signal.</p> <p>The 0-1-0 transition of the signals, to be considered valid, must take place in a time between 500 msec and 5 sec.</p> <p>Available with M1S.</p>
---	--

Reset operator

	<p><b>Reset</b></p> <p>This operator resets the Mosaic system in presence of errors on the inputs or outputs.</p> <p>This operator generates a reset of the system when the corresponding input is a double transition OFF-ON-OFF of less than 5s.</p> <p><a href="#">More info: "Reset operator" on page 29.</a></p>
--	---

## Safety Guard Lock operator



### Guard Lock

The Guard lock operator controls locking/unlocking of an electromechanical guard lock by analysing consistency between the Lock command and the status of an E-GATE and a FEEDBACK.

More info: "Guard Lock operator" on page 32.

### Digital comparator



The Digital Comparator operator allows to compare a series of input signals (from 2 to 8 max.) with a decimal constant (range 0 to 255).

The input In1 is the LSB (least significant bit) while the input In8 (or lower if the number of inputs selected is less than 8) is the MSB (most significant bit).

The comparators are: <Less; > = Greater or equal; > Greater; <= Less or equal; = Equal; != Different

Selecting "Signal Comparison", the Digital comparator operator will compare the first four inputs A (In1\_A ... In4\_A) and the second four inputs B (In1\_B ... In4\_B).

The comparators are the same as described above.

Available with M1S.

## Network operator

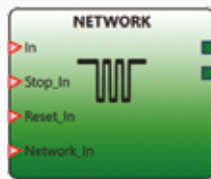

### Network

Is a serial connection (Loop) of several Mosaic Master unit (with possible expansions). This operator allows stop and reset commands to be distributed in a simply Mosaic network.

More info: "Network operator" on page 32.

## Counter operators



### Counter

Counter operator is a pulse counter that sets output Q to 1 (TRUE) as soon as the desired count is reached. There are 3 operating modes: Automatic, Manual, Automatic + Manual.



### Counter Comparator

This operator allows to compare the counter value with the set threshold value. The output will be kept at 0 (FALSE) until the counter value is lower than the threshold value. The output will be set to 1 (TRUE) for counter values equal to or greater than the threshold value.

Warning: the Counter Comparator operator can only be connected to an output of the Counter operator.

Available with M1S.

## Muting operator objects



### L Muting

With 2 Muting sensors for one-way openings (exit only). Suitable solution for any applications of pallet exit.

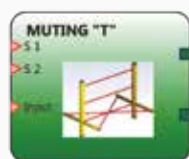

### T Muting

With 2 Muting sensors for two-way openings (entry/exit). Suitable solution for the most common pallet infeed/outfeed applications.

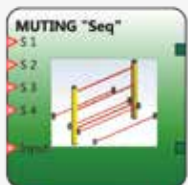

### T Muting "Sequential"

With 4 Muting sensors for two-way openings (entry/exit). Suitable solution for transparent material and application with presence of a pallet with reduced width or not centred with respect to the conveyor.

More info: T Muting «Sequential» on page 30.

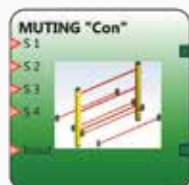

### T Muting "Concurrent"

With 4 Muting sensors for two-way openings (entry/exit). Suitable solution for transparent material and application with presence of a pallet with reduced width or not centred with respect to the conveyor.

More info: T Muting «Concurrent» on page 30.



### Muting Override

Are available two selectable functional mode: Override with hold to run action  
Override with one pulse action.

More info: "Muting Override" on page 30.

# INSIGHTS

## A DETAILED LOOK INTO THE MOST INTERESTING FEATURES OF MOSAIC MSD

### Property window

The property window of each function block allows configuring each block parameters in a simple and easy way.

This allows achieving an important level of customisation for each project tailoring Mosaic behaviour to each particular application.

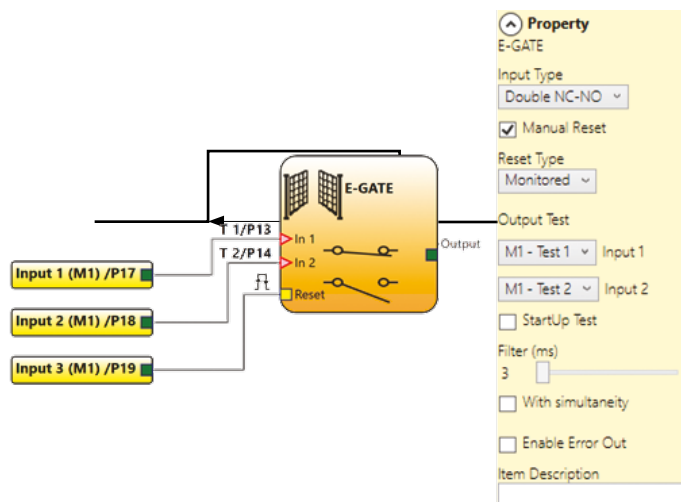

E-gate configuration example

### Network\_In

This function block creates a network input interface connection, generating on the OUT output a high logical level (1) when the line is high, 0 otherwise.

This input can only be allocated to Mosaic Master.

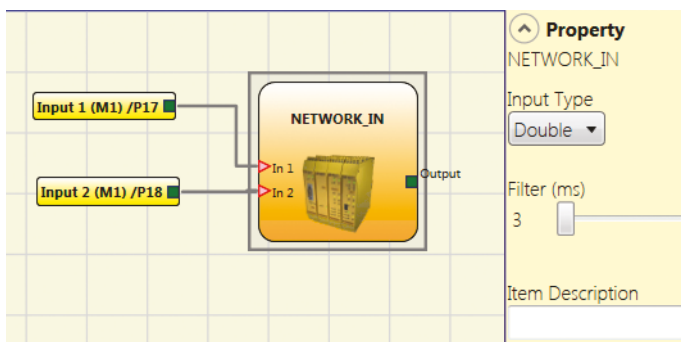

Network\_IN Object

This input must be used when Mosaic OSSD or status outputs are connected to the inputs of a second downstream Mosaic or together with the NETWORK operator.

### Automatic or Manual Reset

Manual Reset: If selected this enables the request to reset each time the area protected by the safety light curtain is occupied. Otherwise, enabling of the output directly follows the input conditions

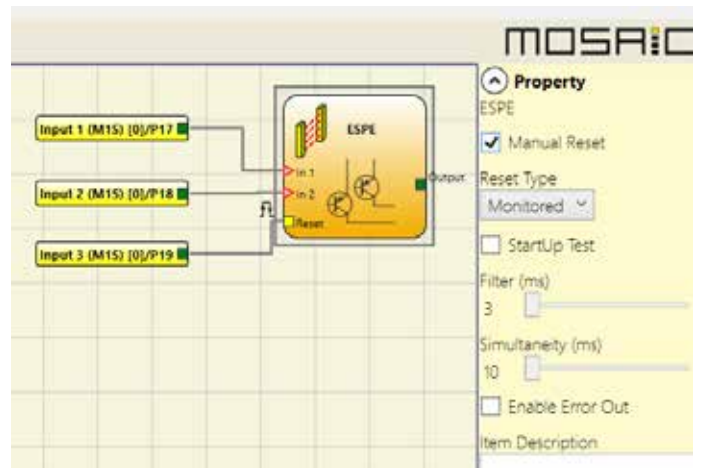

ESPE configuration example

There are two types of reset: Manual and Monitored. When Manual is selected the system only verifies the signal's transition from 0 to 1. If Monitored is selected the double transition from 0 to 1 and then back to 0 is verified.

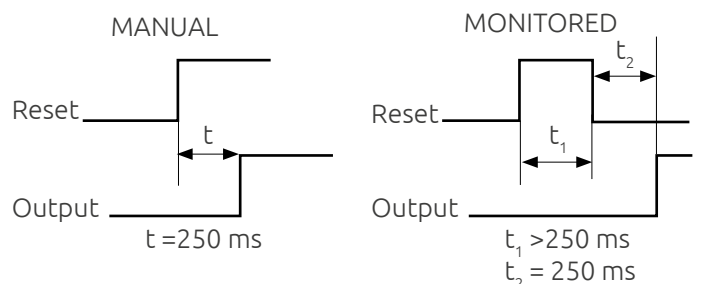

Manual and monitored reset

### Reset operator

This operator resets the Mosaic system in presence of errors on the inputs or outputs.

This operator generates a reset of the system when the corresponding input is a double transition OFF-ON-OFF of less than 5s

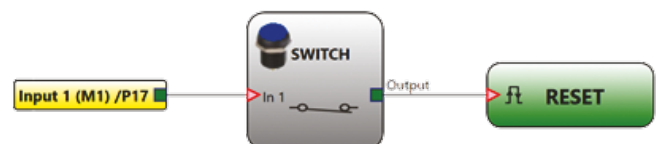

Connection of Reset operator

### Clocking operator

This operator has up to 7 inputs to control the output Duty Cycle. Related to the selected input, this operator will generate a clock with different duty cycle.

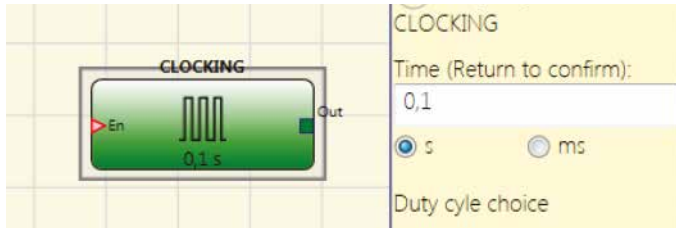

Clocking operator property

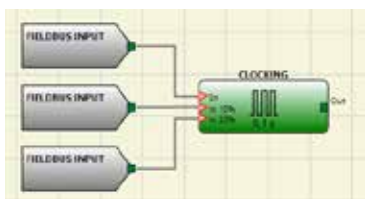

It can be used, for example, to pass or receive the status information to or from a PLC.

Clocking operator connection sample

### T Muting «Sequential»

The activation of the Muting function occurs following sequential interruption of the sensors S1 and S2, subsequently S3 and S4 sensors (without time limit). If the pallet proceeds in the opposite direction the correct sequence is: S4, S3, S2, S1.

Preliminary condition: The Muting cycle can only start if all the sensors are 0 and the inputs are 1 (sensor and light curtain free).

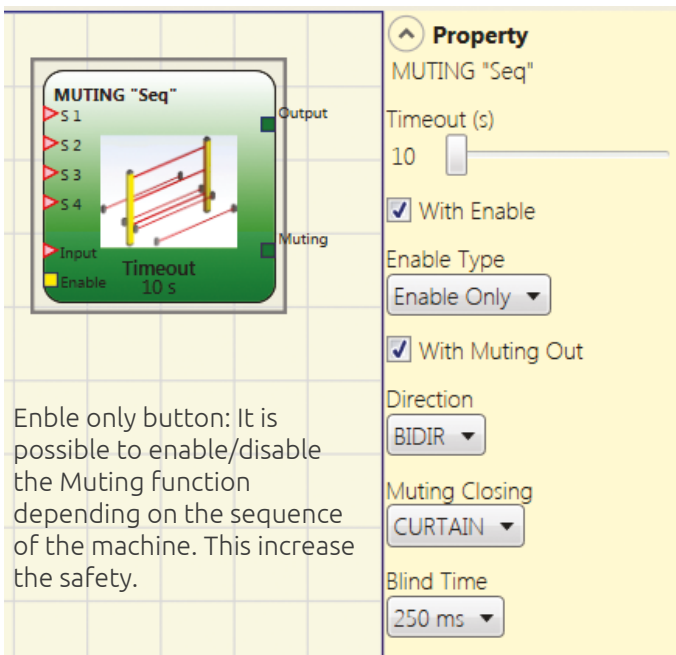

Enable only button: It is possible to enable/disable the Muting function depending on the sequence of the machine. This increases the safety.

Example of Sequential Muting parameters configuration

### T Muting «Concurrent»

The activation of the Muting function occurs following interruption of the sensors S1 and S2 beams and then of the sensor S3 and S4: the two sensors must be interrupted within a configurable safety timeout (sensor time) the maximum duration of the Muting status is limited by a timeout. S1 --X sec. --> S2 ---t--S3 --X sec. --> S4 Where t is a value that depends on the "timeout", X is the "sensor time". The "Minimum sensors time option" allows to stop the Muting function if the transit in front of the sensors 1-2 and 3-4 takes place with a time less than 150 ms. This allows to detect the transit of much faster than a pallet person.

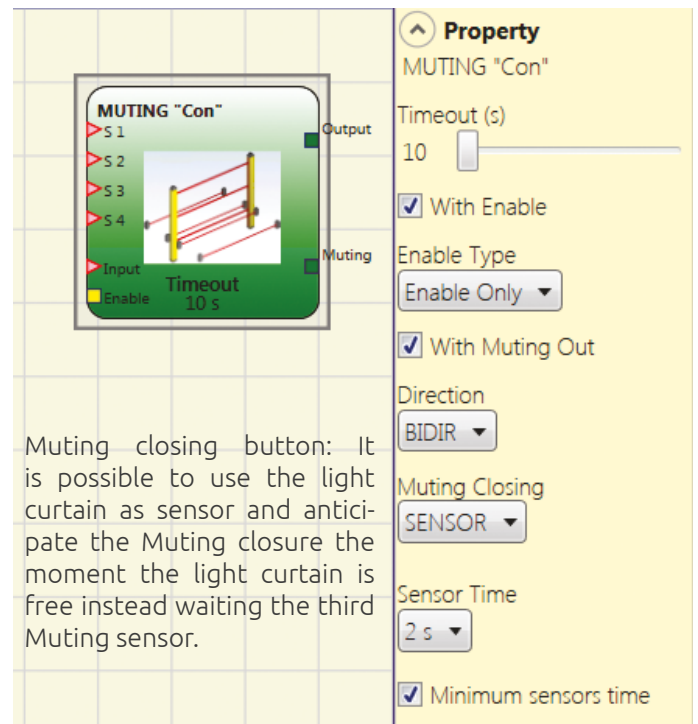

Muting closing button: It is possible to use the light curtain as sensor and anticipate the Muting closure the moment the light curtain is free instead waiting the third Muting sensor.

Example of Sequential Muting parameters configuration

### Muting Override

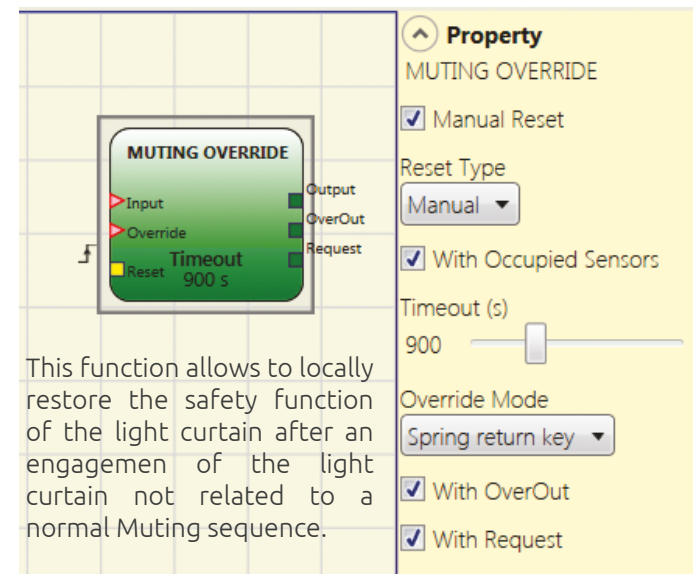

This function allows to locally restore the safety function of the light curtain after an engagement of the light curtain not related to a normal Muting sequence.

Example of Muting override configuration

## Analogic Inputs configuration

The input type “Single” allows to connect one analogue sensor (current or voltage) to the module input. By selecting “Redundant”, it will be possible to connect two analogic sensors to the input of the module. The signals of the two sensors are analysed and compared between each other.

The “Measurement unit” field allows to enter the engineering units measured through the sensor (i.e. Kg, ° C, etc.).

In the “scale” fields, it’s possible to insert the minimum value of the quantity corresponding to the minimum signal coming from the sensor in the “4mA or 0V” box and the maximum value in the “20 mA or 10V” box.

The two check boxes “0-20 mA” and “0-10 V” allows to define the sensor output type: voltage instead of current.

The windows comparator selection activates an analogue window comparator. The output OUT1 will be 1 (TRUE) when the value read by the sensor is between the two thresholds. It will be 0 (FALSE) when the value read by the sensor will be outside the two thresholds. It is also possible to enter a hysteresis value.

Threshold 1,2 fields represents the threshold above which the output OUT1 will be 1 (TRUE). Below the set threshold the output OUT1 will be 0 (FALSE). Also in this case it is possible to insert a hysteresis value.

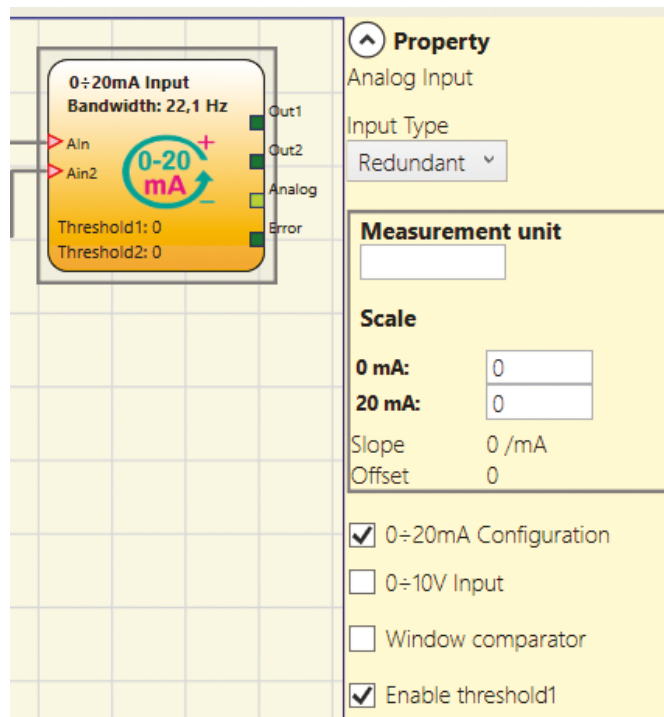

Analogic inputs configuration parameters

In the fields “Samples per second (2.5-4000)” it’s possible to enter the value that determines the number of samples per second of the analogue input signal.

Moreover, It is possible to enter the limit values below which (Minimum current value) or above which (Maximum current value) the ERROR output will be activated.

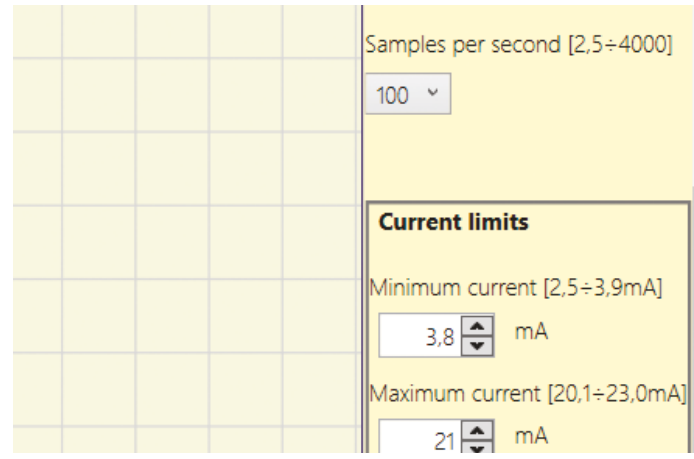

Sample per second of the analogue input configuration

Are also available a series of values that allows to check the correct operation of the analogic sensors.

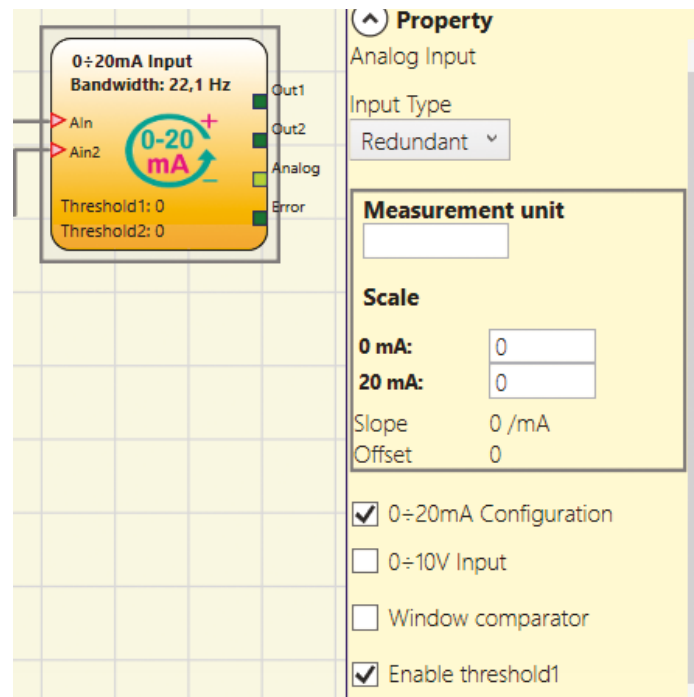

Sensor anomaly configuration

## Guard Lock operator

The Gate input is connected to the functional block e-gate. This is an example of Guard Lock configuration.

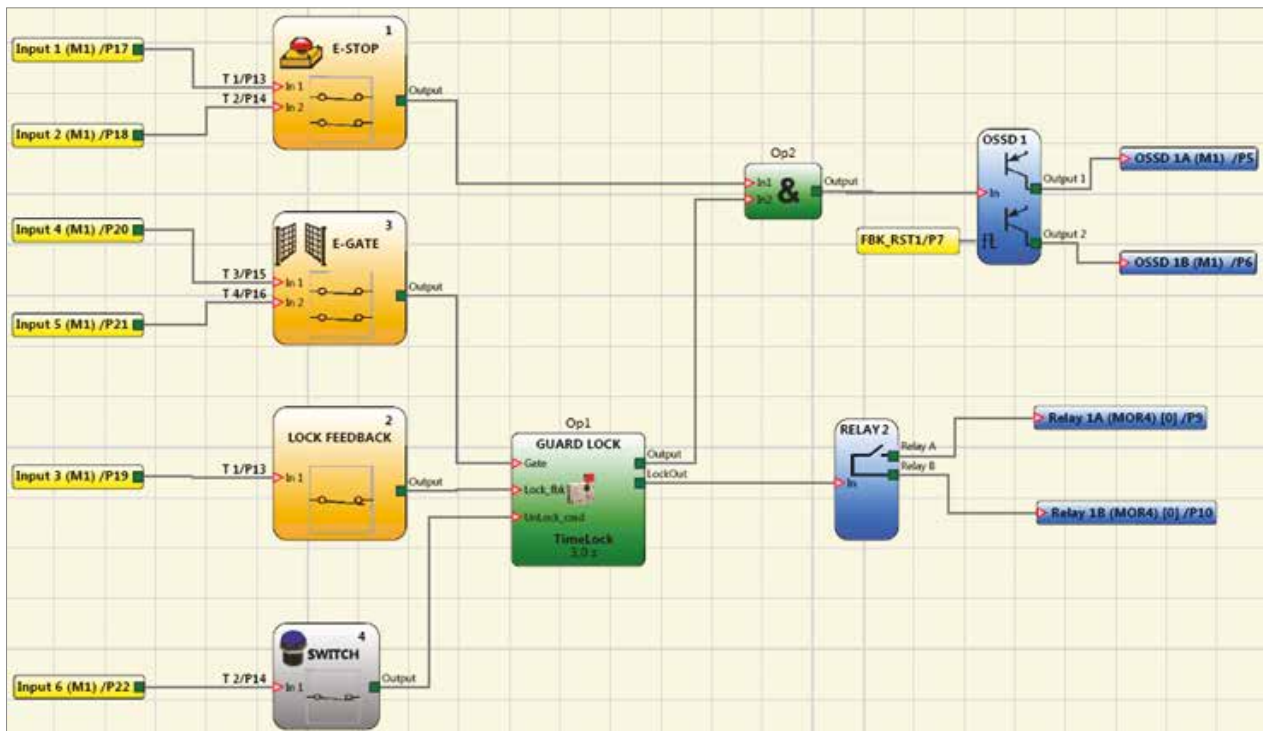

Sample of Guard Lock operator connection

1. The Lock\_fbk input is connected to the functional block Lock\_fbk (feedback from the lock)
2. The UnLock\_cmd input (unlocks command) is connected to an input switch
3. The signal output will be 1 if the door is closed and the guard lock is locked
4. When an unlock command is applied to the input (UnLock\_cmd), the output signal will be set to "0" and after a programmable time Time\_Lock (2 sec. in the example) the guard lock is unlocked through the LockOut output

## Network operator

It allows loop connection (Loop) of several Mosaic Master units (with expansions). This operator allows stop and reset commands to be distributed in the Mosaic network.

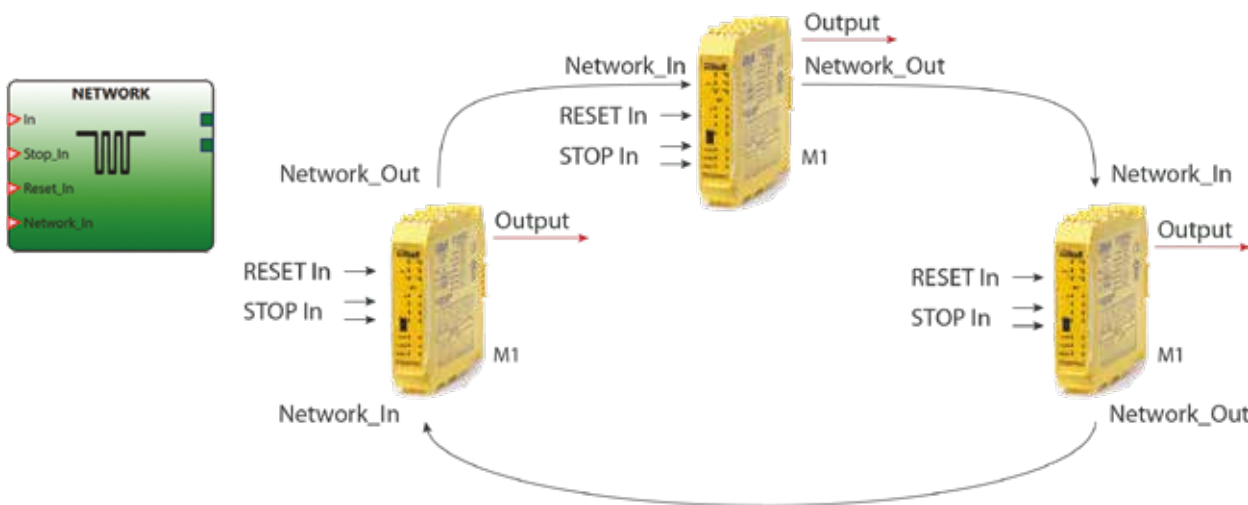

Network connection



### Speed monitoring object configuration example

Example of speed monitoring of one axis. Monitoring of stand still and speed control with selectable 2 thresholds

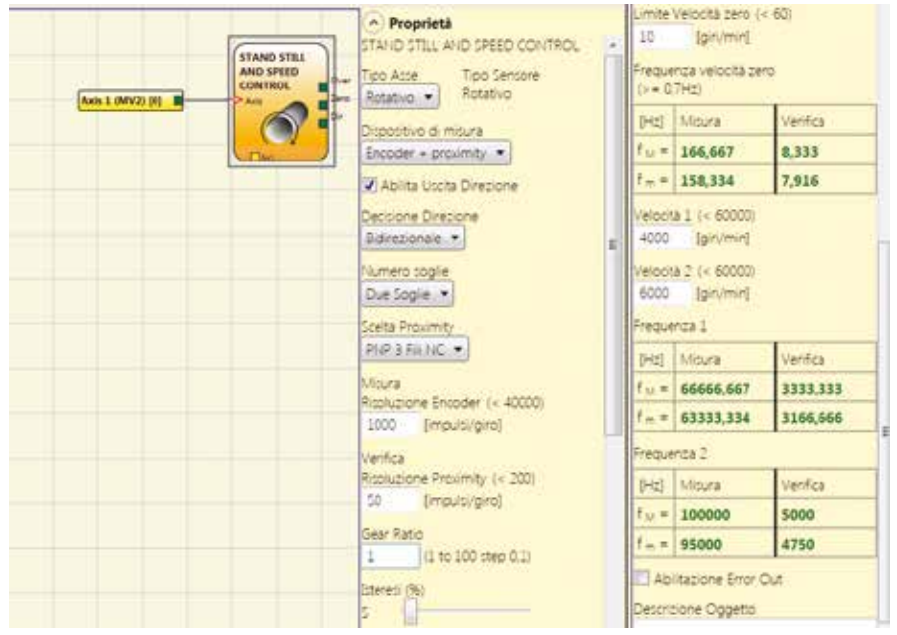

Speed monitoring object configuration example

### Interpage operators

Interpage operators is a label assigning a name to a certain logical interconnection.

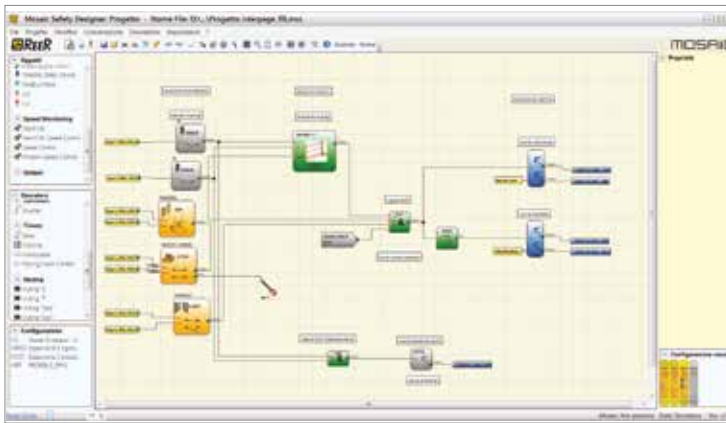
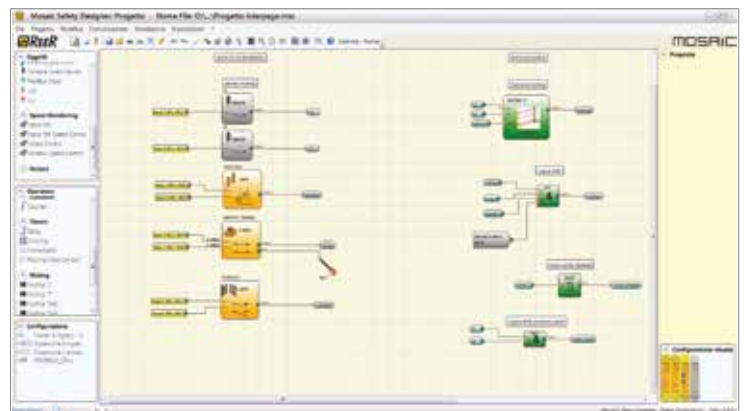
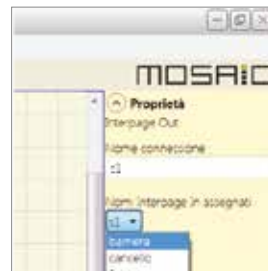

Diagram with wires

Considerable simplification and readability of the diagram.

To simplify the names assignment a drop-down menu, that lets you choose the name of the "Interpage out" among those assigned to the operators "Interpage In"



The same diagram with Interpage function applied

### Interpage operator advantages

# REAL TIME MONITOR

The I/O MONITOR allows the real-time monitoring of all the I/Os of a Mosaic system and the diagnostic information about a working system.

## VISUALIZATION

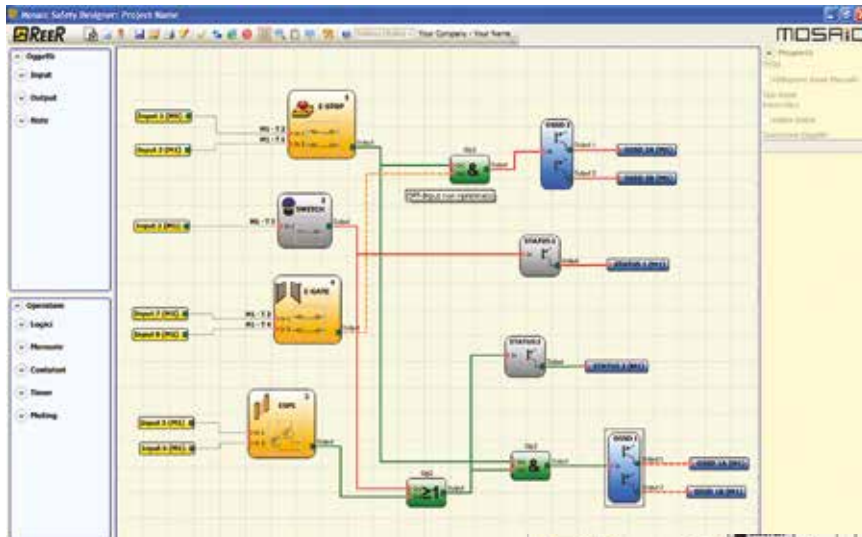

Graphic visualization

Module	Block	Type	INPUT	Status	Diagnose	Module	OSCO	Status	Diagnose	Module	Status	Status	Out Test	Diagnose
M1	1	E-Stop	IN1	ON		M1	OS01	ON		M1	STATUS1	OFF	M1 T1	
M1	2	SWITCH	IN2	OFF		M1	OS02	OFF		M1	STATUS2	ON	M1 T2	
M1	3	ESPE	IN3	ON									M1 T3	
M1	4	E-Gate	IN4	OFF									M1 T4	

Text visualization

Real-time Monitor

# SIMULATION FUNCTION

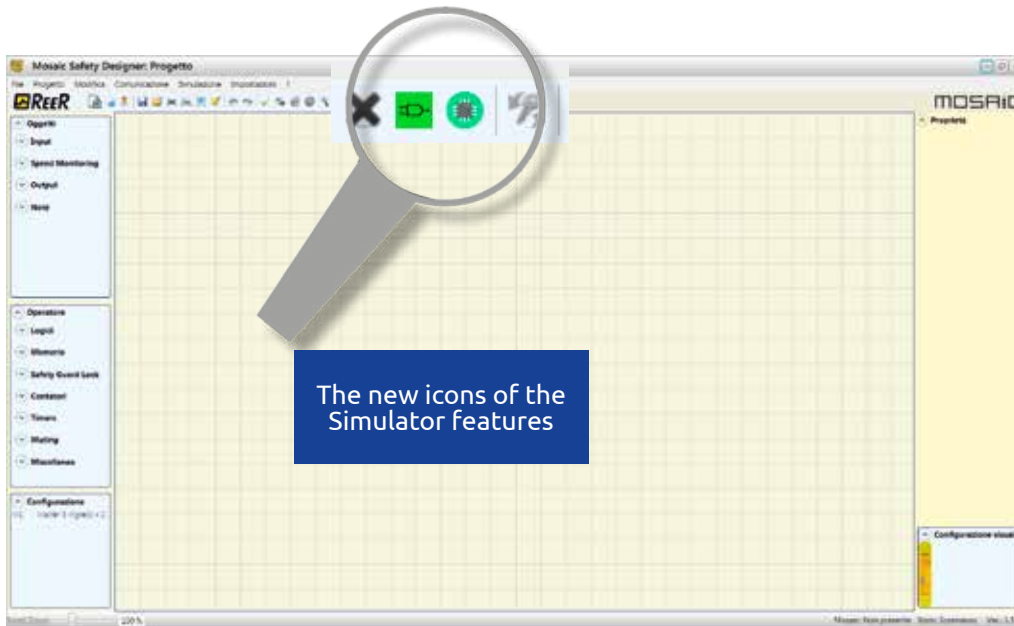

The Simulator allows to verify the functionality and correct operations of a project created with MSD before the assembly of the machinery.

It allows activate the inputs of the system manually or in a programmed way in order to ensure the outputs gained are correct.



Schematic simulation



Graphic simulation

NOTE: the simulation feature is available with MSD version 1.5 and M1 firmware version 3.0 or higher.

## SCHEMATIC SIMULATION

The schematic simulation allows to “start” the project via a dedicated menu and to operate directly on any of the inputs to verify the logic of the system.

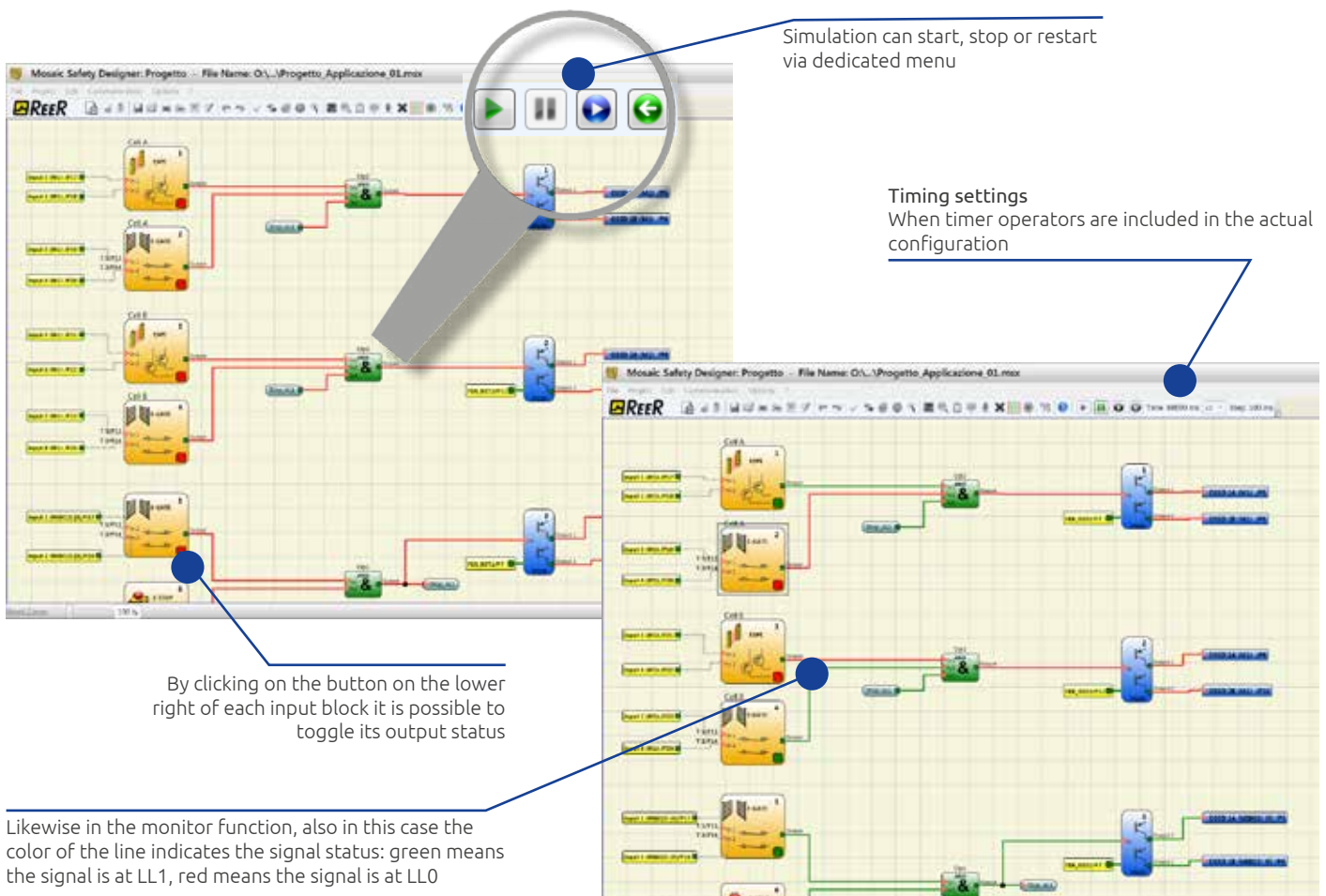

Likewise in the monitor function, also in this case the color of the line indicates the signal status: green means the signal is at LL1, red means the signal is at LL0

## MANAGING GRAPHIC SIMULATION

The graphic simulation allows to load a number of programmed inputs status change and to verify the logic of the system as a graphical output diagram. This methodology allows to create templates replicating the exact functionality of a machinery and apply them on different projects.

### Template Stimuli

Based on the schematic loaded, it creates a template file to fill with the desired values.

The user can modify the status of the input signals in a certain time.

### Parameter Editor

The user must save the file with the required name and open it again with a text editor to modify the parameters.

### Simulation with Stimuli

Load the template file saved and starts the simulation.

```

provast - Blocco note
File Modifica Formato Visualizza ?

// E-Stop
Input6
0:0
500:1
1000:0
1500:1

// OSSD
Fbk_rst1
0:0
500:1
1000:0
1500:1

// OSSD
Fbk_rst2
0:0
500:1
1000:0
1500:1

// OSSD
Fbk_rst3
0:0
500:1
    
```

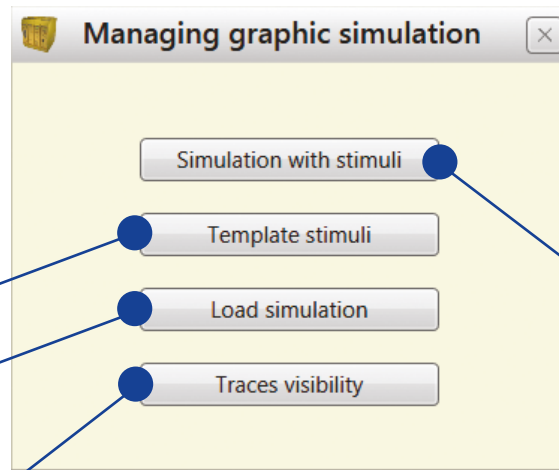

```

provast - Blocco note
File Modifica Formato Visualizza ?

// E-Stop
Input6
0:0
500:1
1000:0
1500:1

// OSSD
Fbk_rst1
0:0
500:1
1000:0
1500:1

// OSSD
Fbk_rst2
0:0
500:1
1000:0
1500:1

// OSSD
Fbk_rst3
0:0
500:1
    
```

### Load simulation

With this feature is it possible to load a previous completed simulation

### Traces visibility

With this option the user could select the traces (waveform signal) to be displayed in the graph or not

At the end of the simulation a graph with all the resulting signals is showed.

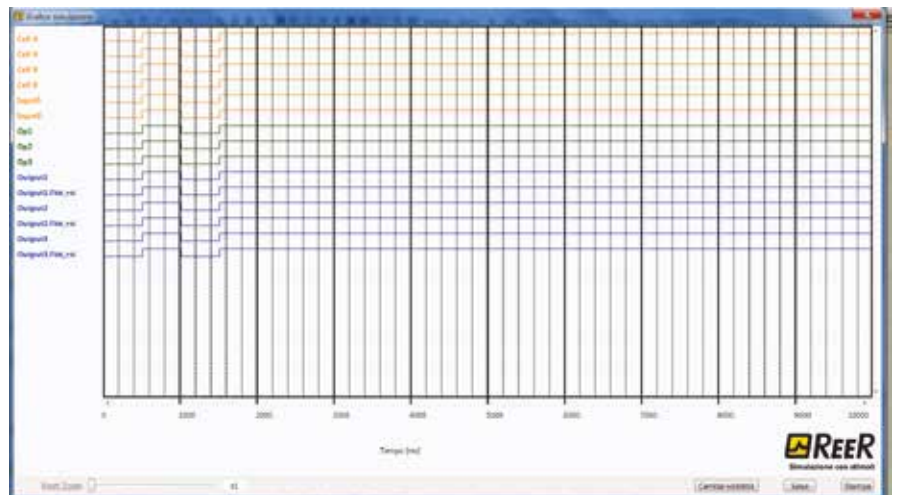

# HSD SOFTWARE

## MESSAGES EDITOR FOR THE HM1 DISPLAY

HSD is the editor software that allows programming of the HM1 device.

HM1 can be connected to the Mosaic system in 3 ways:

1. Wired to a status output connected to the serial operator, asynchronous serial connection. Max 32 status displayed. See picture 1
2. Wired to 2 status outputs connected to the serial operator, synchronous serial connection. Max 16 status displayed. See picture 2
3. Wired to the serial MBx module via RS 485 serial port, All I/O statuses and diagnostic displayed

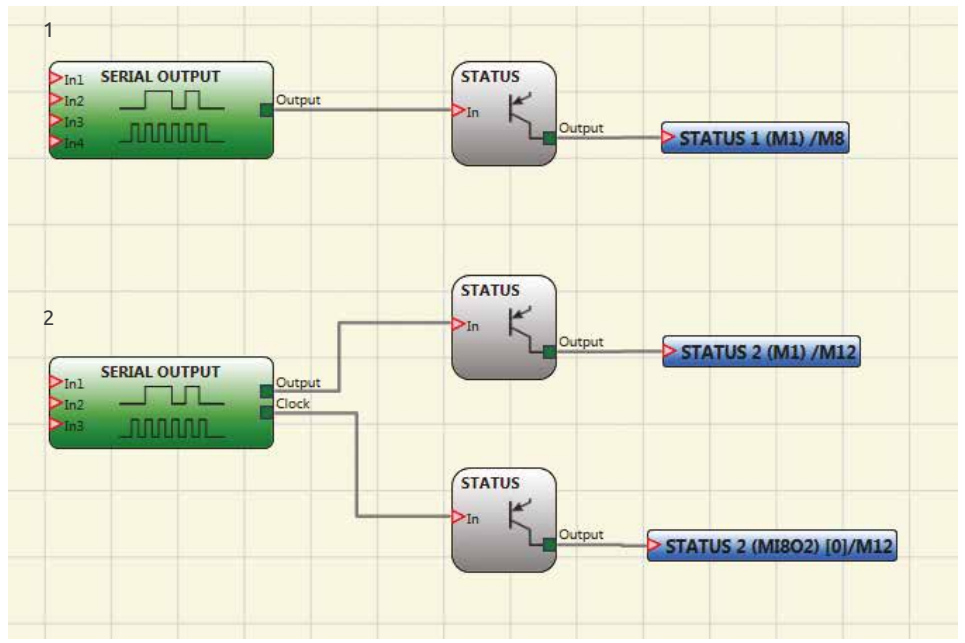

HM1 connections type

The digital signals from the output status or serial operator can be converted to display messages on the display HM1 through this HSD editor software.

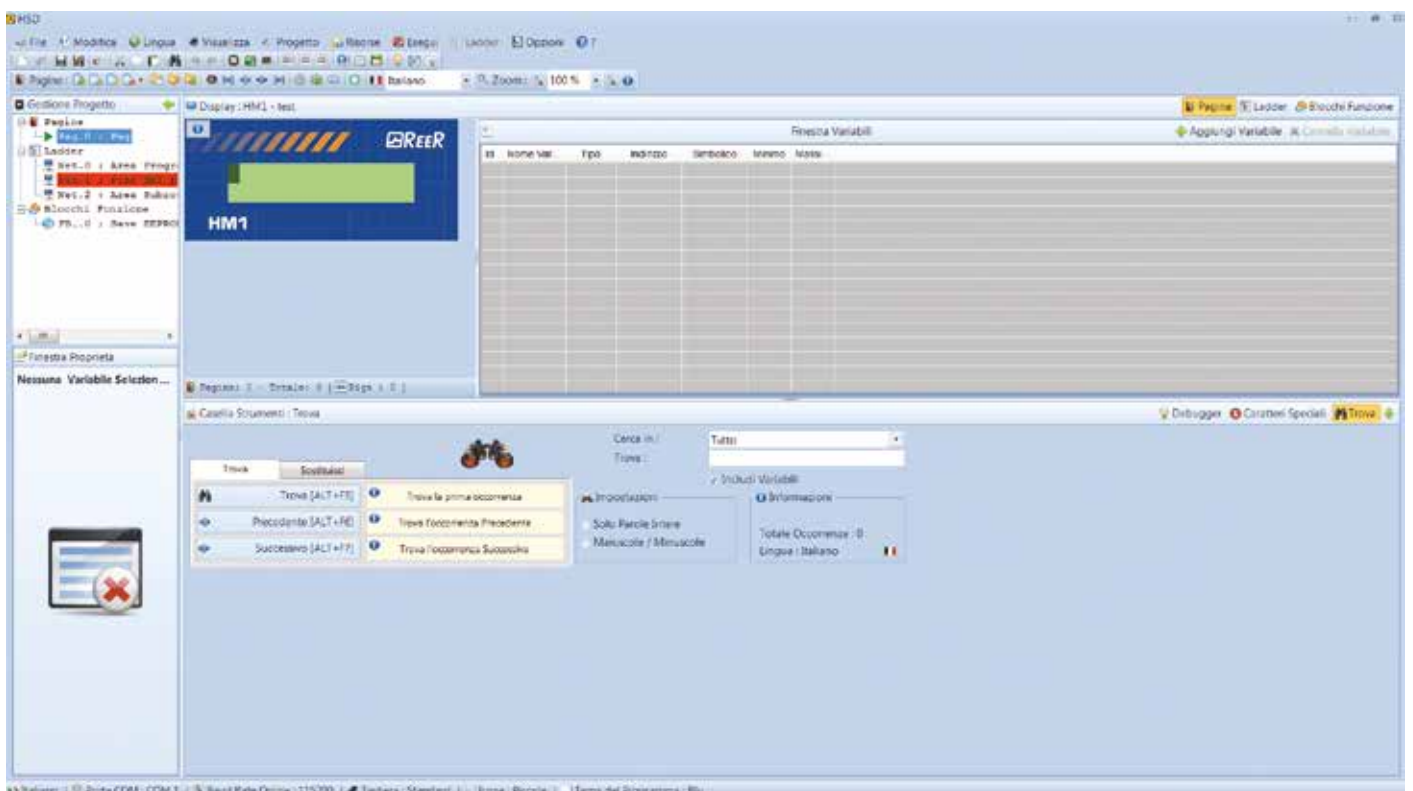

HSD main screen

# APPLICATION EXAMPLES

## SAFETY MANAGEMENT OF A PALLETIZING SYSTEM WITH TWO ROBOTIC CELLS

The system comprises a conveyor that transports boxes to two robotic palletization cells.

The machine is completely protected by a fence with three access gates (one for each robotic cell and one for the conveyor area) equipped with a safety switch. When the gate of the robotic cell is open, the corresponding robot stops. When the conveyor area gate is open the entire plant stops.

The completed pallets are collected by a forklift truck through the access gate which is protected by a safety light curtain. The access of the forklift truck for collecting the pallet, when the robot is stopped in the rest position, by reason of the safety light curtains, prevents the robot to start.

In all other phases of processing, occupation of each light curtain causes the related robot to stop. The related manual restart control is located close to each light curtain. The system is equipped with four emergency push buttons (e-stop).

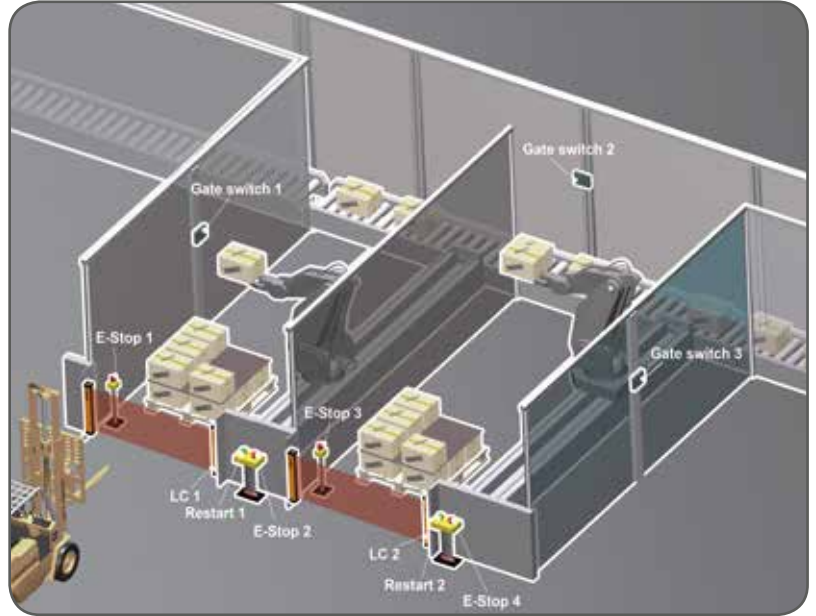

Total safety devices: 2 safety light curtains, 2 restart buttons for the safety light curtains, 3 safety gate switches, 4 emergency push buttons.

Using conventional components – safety relay modules – to build up the safety circuit, it would be necessary to use at least six safety modules, wired to each other in order to perform the required functions: 2 safety relays for the light curtains, 3 safety relays for the gate switches, 1 safety relay for the emergency stop chain.

### Solution with Mosaic

Using Mosaic to build up the safety circuit, it is sufficient to use:

- 1 M1 or M1S Master unit
- 1 MI8O2 expansion unit

**Note 1:** the Reset buttons are not displayed on the diagram because they are directly connected to the feedback of the OSSD safety outputs (inputs FBK\_RST1, FBK\_RST2). The 4 E-STOP are connected in series and in the diagram they are represented with a single block.

**Note 2:** 3 operators Interpage (2 In and 1 Out) were included in the diagram. These allow you to link the inputs and outputs of the logic gates “&” without having to draw the line.

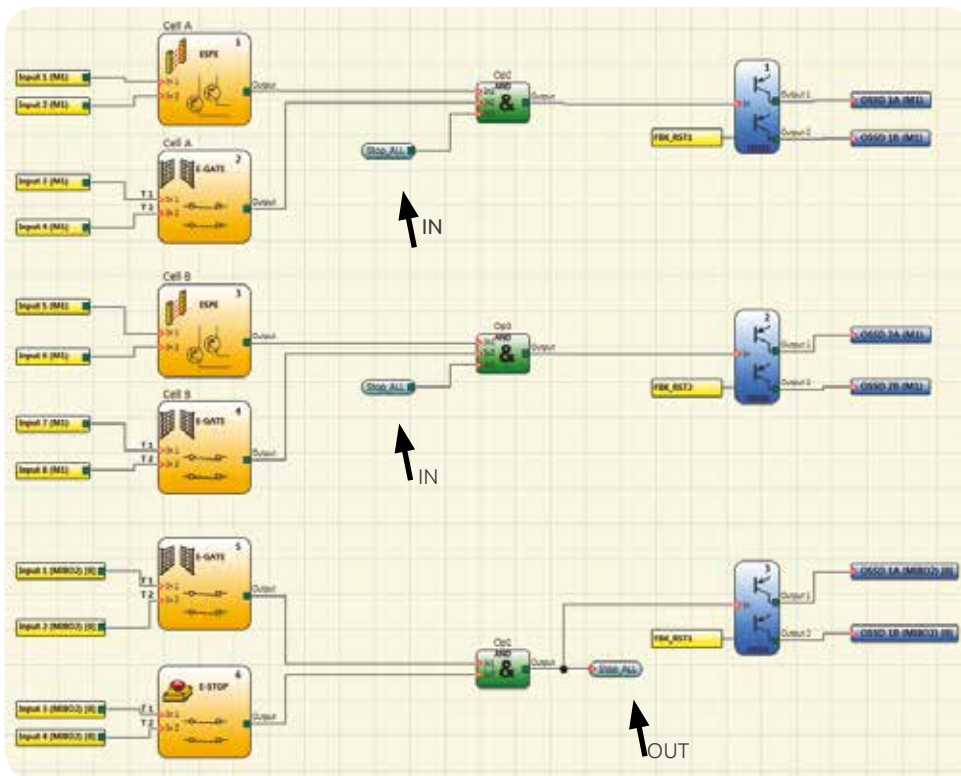

16 inputs - 4 OSSD pairs - 8 test outputs - 4 signal outputs

## SAFETY MANAGEMENT OF A MACHINING CENTRE WITH ALTERNATE LOAD / UNLOAD

The operator is required to load and unload the workpiece. The machine is protected by two horizontal safety light curtains. In this case, each light curtain must be equipped with the Muting function so as to permit access to the hazardous area by personnel during the non-hazardous part of the machine cycle.

Depending on the position of the tool, which is the hazardous element, one of the two light curtains (the one facing the tool working area) is active, while the other is muted so that the operator can load/unload the workpiece.

The Muting condition of the two safety light curtains will then be inverted when the tool is required to operate on the opposite side of the machine.

The machine is completely protected by a fence with an access gate equipped with a safety switch. When the gate is opened, the machine stops. The related manual restart control is located close to each safety light curtain. The system is equipped with three emergency push buttons which, if activated, stop the machine.

Total safety components: 2 safety light curtains, 2 restart buttons for the safety light curtains, 1 safety gate switch, 3 emergency push buttons.

Using conventional components – safety relay modules – to build up the safety circuit, four safety modules would be necessary: 2 safety modules for the safety light curtains with Muting function, 1 safety module for the gate switch, 1 safety module for the emergency stop.

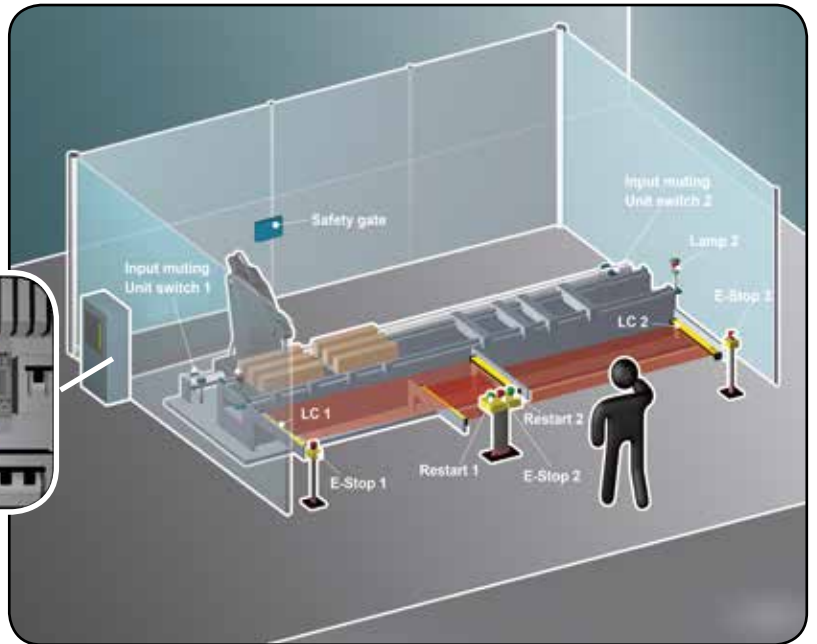

### Solution with Mosaic

Using Mosaic to build up the safety circuit, it is sufficient to use:

- 1 M1 or M1S Master unit
- 1 MI8 expansion unit

**NOTE:** the Reset buttons are not displayed on the diagram because they are directly connected to the feedback of the OSSD safety outputs (inputs FBK\_RST1, FBK\_RST2).

The 3 E-STOP are connected in series and are represented in the diagram with a single block.

The diagram also shows 2 status outputs used to drive the indication lights of the active Muting.

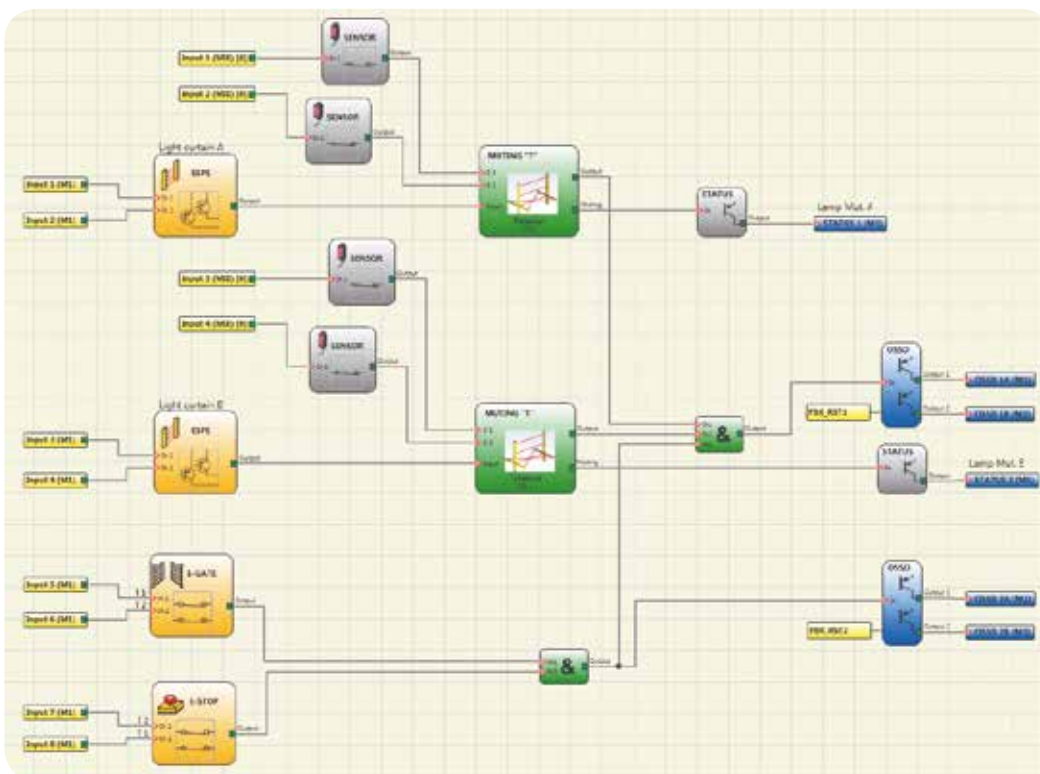

16 inputs - 2 OSSD pairs - 8 test outputs - 2 signal outputs

## SPEED MONITORING FOR A HAZARDOUS TOOL

In this example, to place or remove tooling or to perform maintenance activity where is necessary for the operator to enter the dangerous area.

As long as the tool is working at the normal speed the GUARD LOCK is locked and the access to the hazardous area is not allowed.

Access to the hazardous area is allowed either when the working cycle is over or when the operator switches the MOD SEL to "Access Request". When the tool stops the lock is unlocked and allows the opening of the door. In this case the speed controller verifies that the tool is stopped (zero speed).

For maintenance, it is necessary that the system operates at reduced speed. The operator will have to act on the selector (MOD-SEL) and bring it in the "Maintenance" position. When the tool stops the lock is unlocked and allows the door opening. If the tool has to be kept moving for maintenance reasons as the operator is inside the hazardous area, this is possible through the Grip Switch. The speed monitoring device detects whether the speed of the tool is under a defined threshold set through the MSD. If the threshold is exceeded or the Grip Switch is released the machine is immediately stopped.

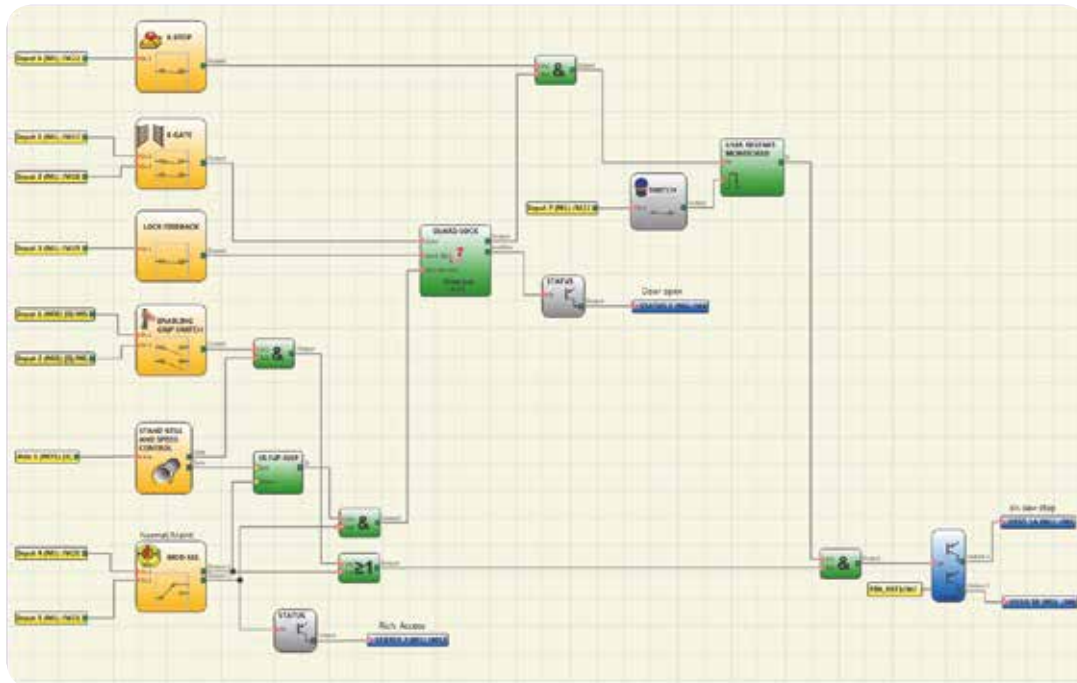
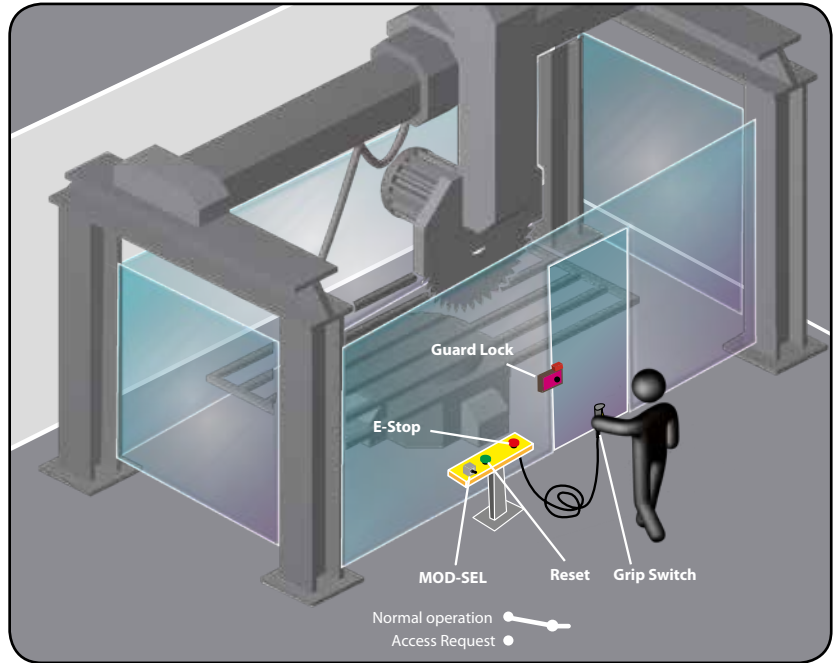

Safety speed monitoring

### Comments

Using Mosaic, all the safety logic circuitry is implemented using the graphic interface and not by hard-wiring the outputs of the relay modules to each other. Correct functioning of the logic circuitry is checked during the design phase by the **validation function** and can be tested with the **simulation** and **monitor function** during installation. During the design phase, safety functions can be easily added or removed, for example adding other sensors or zones. Start up tests can be inserted in order to detect any attempt of by-passing the safety system, which is always a possibility with traditional relay modules.

On the perator panel are available the emergency stop (e-stop) button and reset button to restore the normal operating conditions of the safety lock after the operator intervention.

Using Mosaic to build up the safety circuit, it is sufficient to use:

- 1 M1 or M1S Master unit
- 1 MI6 expansion unit
- 1 MV0 expansion unit for safety speed monitoring



## TYPICAL APPLICATIONS

Pallets production machines



Wood-working machines



Painting machines for wood-working industry



Handling machines for wood-working plants



Wood-working machines squaring edgebanders



Robots



Plastic film production machines



AGVs (Automatic Guided Vehicle)



Pad printing machines



Bending machines



Palletising systems



Palletising and bottling plants



Elevators



Crate packer/unpacker and palletising systems



Beam drilling and sawing machines



Panel sizing saws



Vertical lift storage system



Rail dependent storage and retrieval equipment



Industrial boilers



Industrial thermal processes



Wood working CNC



Cutting tables for glass



Industrial plant application with MA4 Analogic input unit:  
 Loading cells (weight, compression and traction measurements), pressure switches, temperature measurements, flow measurements, level measurements, etc.





## **REEER** *Customer Service*

We put our Customers always first

ReeR after sales service is committed to support all customers that need technical guidance regarding functionality, handling and installation of our products.

Customer Service Hotline

+39 011 24 82 215

Monday to Friday 8.30 - 12.30 and 13.30-18.00 (CET)

or contact  
[aftersales@reer.it](mailto:aftersales@reer.it)

For product returns please visit [www.reersafety.com](http://www.reersafety.com) for further information.



*Your future's safe!*

## 60 years of quality and innovation

Founded in Turin (Italy) in 1959, ReeR distinguished itself for its strong commitment to innovation and technology.

A steady growth throughout the years allowed ReeR to become a point of reference in the safety automation industry at a worldwide level.

The Safety Division is in fact today a world leader in the development and manufacturing of safety optoelectronic sensors and controllers.

ReeR is ISO 9001, ISO 14001 and ISO 45001 certified.



**ReeR SpA**  
Via Carcano, 32  
10153 Torino, Italy

T +39 011 248 2215  
F +39 011 859 867

[www.reersafety.com](http://www.reersafety.com) | [info@reer.it](mailto:info@reer.it)



Issue 2 - Rev. 1.3  
October 2019  
8946225  
MOSAIC - English

*Printed in Italy*

