

**Characteristics**

The proportional directional valves D3FB (NG10) are available with and without onboard electronics (OBE).

**D3FB OBE**

The digital onboard electronics is situated in a robust metal housing, which allows the usage under rough environmental conditions.

The nominal values are factory set. The cable connection to a serial RS232 interface is available as accessory.

**D3FB for external electronics**

The parameters can be saved, changed and duplicated in combination with the digital power amplifier PWD00A-400.

The valve parameters can be edited with the common ProPxD software for both versions.

The D3FB valves can be ordered with spool/sleeve design (D3FB\*0) for maximum precision as well as spool/body design (D3FB\*3) for high nominal flow - see functional limit curves for maximum flow capability.

**Features**

- Spool/sleeve and spool/body
- 3 command options for D3FB OBE:  
+/- 10 V, 4...20 mA, +/- 20 mA
- High repeatability from valve to valve
- Low hysteresis
- Manual override
- Digital onboard electronics



D3FB



D3FB OBE

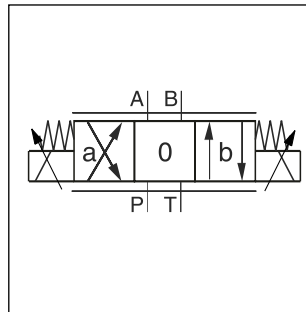

D3FB

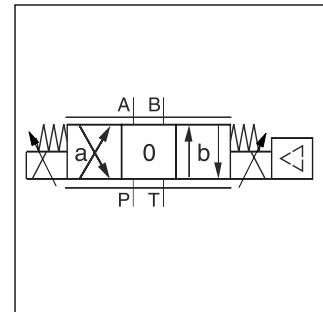

D3FB OBE



**D3FB\*0 OBE**  
Spool/sleeve design

**D3FB\*3 OBE**  
Spool/body design

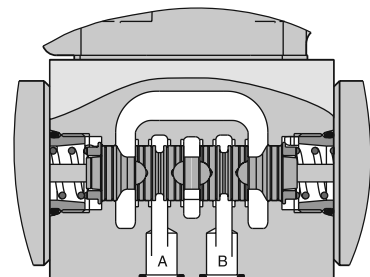
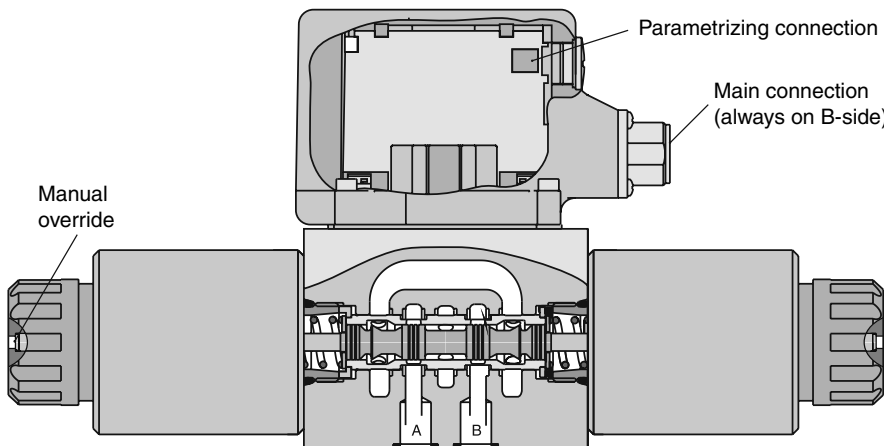

**D3FB**

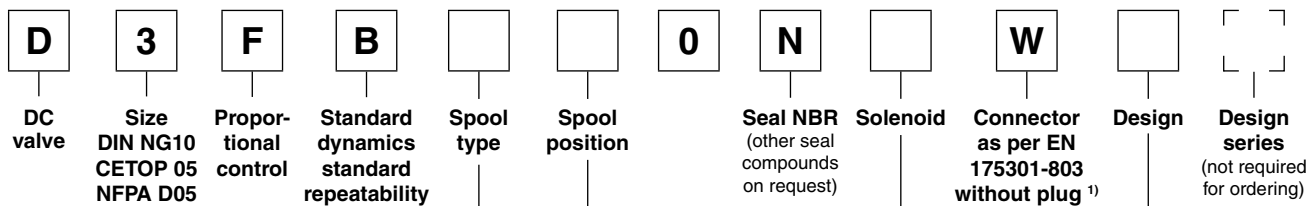

D3FB*0: Spool/sleeve design		
Code	Spool type	Flow [l/min] at Δp 5 bar per metering edge
Overlap		
<b>E01M</b> <b>E01S</b>		40 60
<b>E02M</b> <b>E02S</b>		40 60
<b>B31M</b> <b>B31S</b>	$Q_B = Q_A / 2$ 	40 / 20 60 / 30
<b>B32M</b> <b>B32S</b>	$Q_B = Q_A / 2$ 	40 / 20 60 / 30

D3FB*3: Spool/body design		
Code	Spool type	Flow [l/min] at Δp 5 bar per metering edge
Overlap		
<b>E01M</b> <b>E01S</b> <b>E01U</b>		40 60 80
<b>E02M</b> <b>E02S</b> <b>E02U</b>		40 60 80
<b>B31M</b> <b>B31S</b> <b>B31U</b>	$Q_B = Q_A / 2$ 	40 / 20 60 / 30 80 / 40
<b>B32M</b> <b>B32S</b> <b>B32U</b>	$Q_B = Q_A / 2$ 	40 / 20 60 / 30 80 / 40

Code	Design
0	Spool/sleeve design
3	Spool/body design

D3FB*0: Spool/sleeve design	
Code	Solenoid
K	12 V / 2.95 A

D3FB*3: Spool/body design	
Code	Solenoid
K	12 V / 2.95 A
J	24 V / 1.5 A

Code	Design
C	
E	
K	

Short delivery time for all variations

For regenerative and hybrid function refer solution with sandwich and adaptor plates "A10-1664 / A10-1665L / H10-1662 / H10-1666L" in chapter 12.

<sup>1)</sup> Please order connector separately, see chapter 3 accessories.

**D3FB OBE (with onboard electronics)**

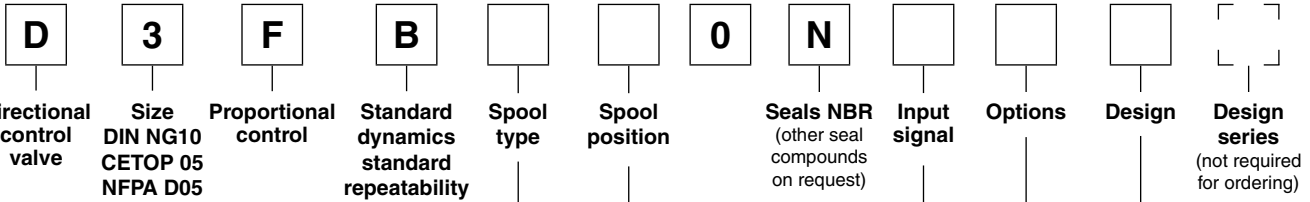

**3**

D3FB*0: Spool/sleeve design		
Code	Spool type	Flow [l/min] at Δp 5 bar per metering edge
Overlap		
E01M E01S		40 60
E02M E02S		40 60
B31M B31S	$Q_b = Q_a/2$ 	40 / 20 60 / 30
B32M B32S	$Q_b = Q_a/2$ 	40 / 20 60 / 30

D3FB*3: Spool/body design		
Code	Spool type	Flow [l/min] at Δp 5 bar per metering edge
Overlap		
E01M E01S E01U		40 60 80
E02M E02S E02U		40 60 80
B31M B31S B31U	$Q_b = Q_a/2$ 	40 / 20 60 / 30 80 / 40
B32M B32S B32U	$Q_b = Q_a/2$ 	40 / 20 60 / 30 80 / 40

Code	Design
0	Spool/sleeve design
3	Spool/body design

Code	Input signal <sup>1)</sup>	Function	Port	Options
F0	0...+/-10 V	0...+10 V > P-A	6 + PE	Potentiometer supply
G0	0...+/-20 mA	0...+20 mA > P-A	6 + PE	—
S0	4...20 mA	12...20 mA > P-A	6 + PE	—
W5 <sup>2)</sup>	0...+/-10 V 4...20 mA	0...+10 V > P-A 12...20 mA > P-A	11 + PE	Command channel & potentiometer supply

Code	Design
C	
E	
K	

Short delivery time for all variations

For regenerative and hybrid function refer solution with sandwich and adaptor plates "A10-1664 / A10-1665L / H10-1662 / H10-1666L" in chapter 12.  
 Please order connector separately, see chapter 3 accessories.  
 Parametrizing cable OBE → RS232: Item no. 40982923

<sup>1)</sup> Single solenoid always 0...+10 V respectively 4...20 mA.  
<sup>2)</sup> Factory set ±10 V on delivery.

<b>General</b>		
Design	Direct operated proportional DC valve	
Actuation	Proportional solenoid	
Size	NG10 / CETOP 05 / NFPA D05	
Mounting interface	DIN 24340 / ISO 4401 / CETOP RP121 / NFPA	
Mounting position	unrestricted	
Ambient temperature	[°C]	-20...+60
MTTF <sub>D</sub> value <sup>1)</sup>	[years]	150
Weight (OBE)	[kg]	6.5 (7.2)
Vibration resistance	[g]	10 Sinus 5...2000 Hz acc. IEC 68-2-6 30 Random noise 20...2000 Hz acc. IEC 68-2-36 15 Shock acc. IEC 68-2-27
<b>Hydraulic</b>		
Max. operating pressure	[bar]	Ports P, A, B 350, T 210
Max. pressure drop PABT / PBAT	[bar]	350
Fluid	Hydraulic oil according to DIN 51524 ... 535, other on request	
Fluid temperature	[°C]	-25...+60
Viscosity permitted	[cSt] / [mm <sup>2</sup> /s]	20...400
Viscosity recommended	[cSt] / [mm <sup>2</sup> /s]	30...80
Filtration	ISO 4406 (1999); 18/16/13	
Nominal flow at Δp=5 bar per control edge <sup>2)</sup>	<b>D3FB*0 (Spool/sleeve)</b>	
	40 / 60	
Leakage at 100 bar	<b>D3FB*3 (Spool/body)</b>	
	40 / 60 / 80	
Opening point (OBE)	[ml/min]	<100
Opening point (OBE)	[ml/min]	<100
Opening point (OBE)	[%]	see flow characteristics (set to 10 command signal)
<b>Static / Dynamic</b>		
Step response at 100 % step	[ms]	40
Hysteresis	[%]	<4
Temperature drift solenoid current	[%/K]	<5
Temperature drift solenoid current	[%/K]	<0.02
<b>Electrical characteristics</b>		
Duty ratio	[%]	100 ED; CAUTION: Coil temperature up to 150 °C possible
Protection class	IP65 in accordance with EN 60529 (with correctly mounted plug-in connector)	
Solenoid	<b>Code "K"</b>	
Supply voltage	[V]	<b>Code "J"</b>
Current consumption	[A]	12
Resistance	[Ohm]	24
Solenoid connection	Connector as per EN 175301-803	
Wiring min.	[mm <sup>2</sup> ]	2.95
Wiring length max.	[m]	1.5
Wiring length max.	[m]	3.84
Wiring length max.	[m]	16.25

<sup>1)</sup> If valves with onboard electronics are used in safety-related parts of control systems, in case the safety function is requested, the valve electronics voltage supply is to be switched off by a suitable switching element with sufficient reliability.

<sup>2)</sup> Flow rate for different Δp per control edge:  $Q_x = Q_{Nom.} \cdot \sqrt{\frac{\Delta p_x}{\Delta p_{Nom.}}}$

**Technical Data**

3

Electrical characteristics OBE		
Duty ratio	[%]	100 ED; CAUTION: coil temperatures up to 150 °C possible
Protection class		IP65 in accordance with EN 60529 (with correctly mounted plug-in connector)
Supply voltage/ripple DC	[V]	18...30, ripple < 5 % eff., surge free
Current consumption max.	[A]	3.5
Pre fusing medium lag	[A]	4.0
Input signal		
Codes F0 & W5 voltage	[V]	+10...0...-10, ripple < 0.01 % eff., surge free, Ri = 100 kOhm, 0...+10 V ⇒ P -> A
Codes S0 & W5 current	[mA]	4...12...20, ripple < 0.01 % eff., surge free, Ri = <250 Ohm, 12...20 mA ⇒ P -> A < 3.6 mA = enable off, > 3.8 mA = enable on (acc. to NAMUR NE43)
Code G0	[mA]	+20...0...-20, ripple < 0.01 % eff., surge free, Ri = <250 Ohm, 0...+20 mA ⇒ P -> A
Differential input max.		
Codes F0, G0 & S0	[V]	30 for terminal D and E against PE (terminal G) 11 for terminal D and E against 0V (terminal B)
Code W5	[V]	30 for terminal 4 and 5 against PE (terminal PE) 11 for terminal 4 and 5 against 0V (terminal 2)
Channel recall signal	[V]	0...2.5: off / 5...30: on / Ri = 100 kOhm
Adjustment ranges		
Min	[%]	0...50
Max	[%]	50...100
Ramp	[s]	0...32.5
Interface		RS 232, parametrizing connection 5pole
EMC		EN 61000-6-2, EN 61000-6-4
Central connection		
Codes F0, G0 & S0		6 + PE acc. to EN 175201-804
Code W5		11 + PE acc. to EN 175201-804
Wiring min.		
Codes F0, G0 & S0	[mm <sup>2</sup> ]	7 x 1.0 (AWG16) overall braid shield
Code W5	[mm <sup>2</sup> ]	11 x 1.0 (AWG16) overall braid shield
Wiring length max.		50

**Flow characteristics**  
**D3FB external electronics**  
 at  $\Delta p = 5$  bar per metering edge  
 Spool type E01/02, B31/32

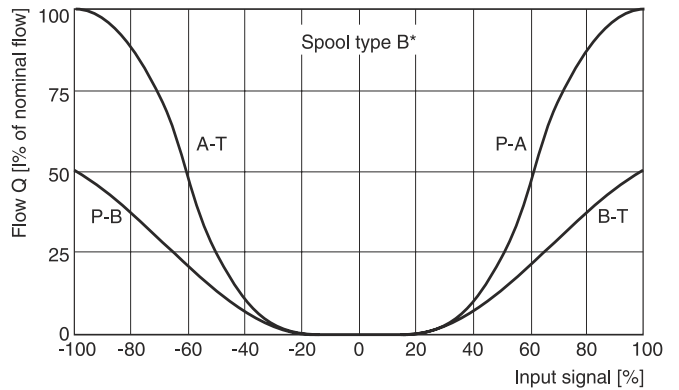
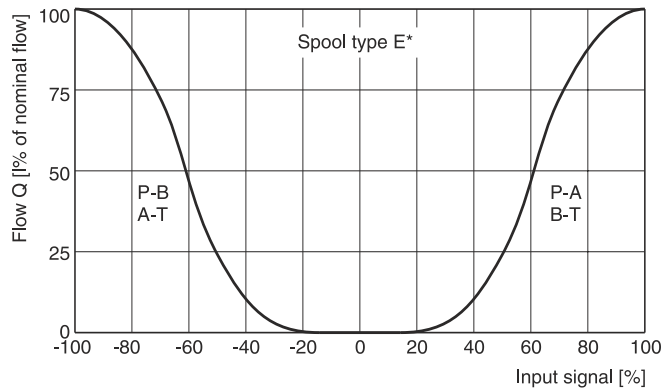

**D3FB OBE**  
 (set to opening point 10 %)  
 at  $\Delta p = 5$  bar per metering edge  
 Spool type E01/02, B31/32

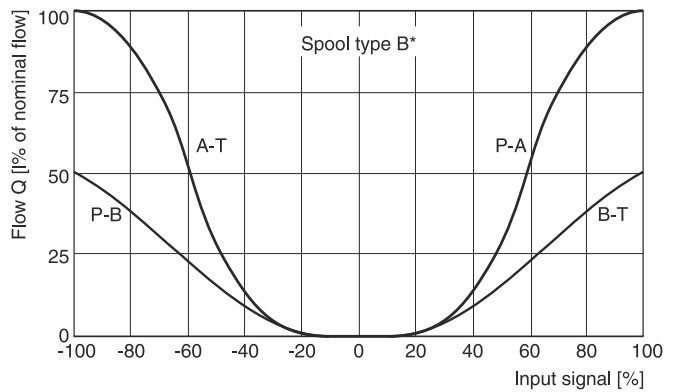
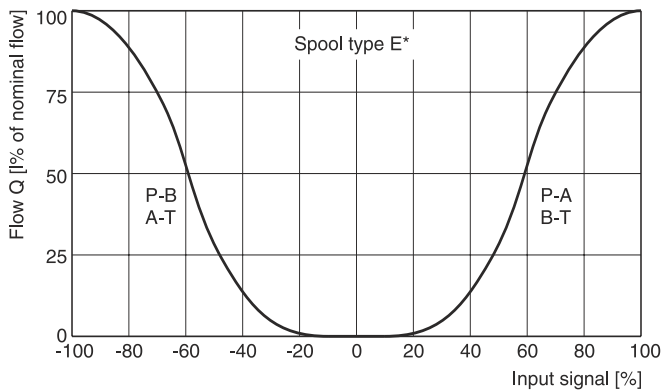

**Functional limits**

100 % command signal (symmetric flow). At asymmetric flow a reduced flow limit has to be considered.

**D3FB\*0**

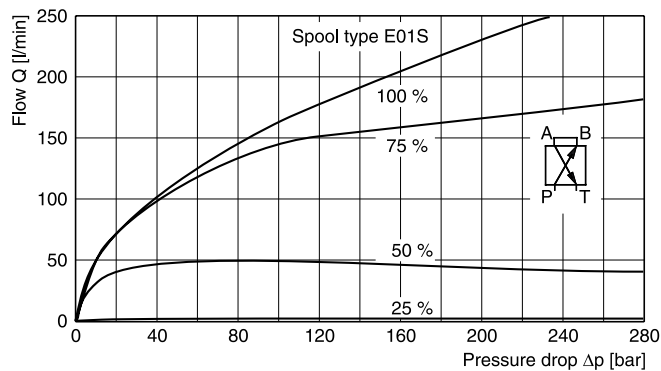

**D3FB\*3**

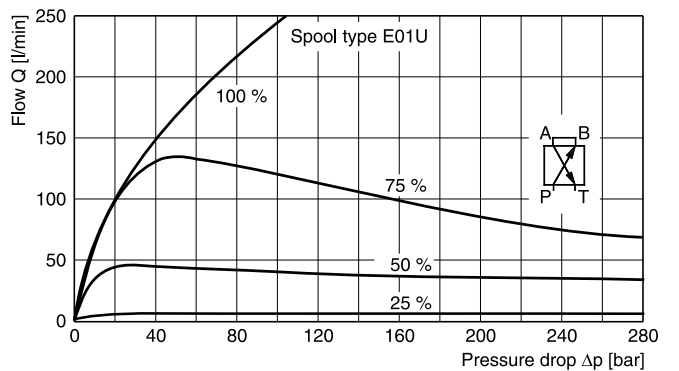

All characteristic curves measured with HLP46 at 50 °C.

**Code F0**  
 6 + PE acc. to EN 175201-804

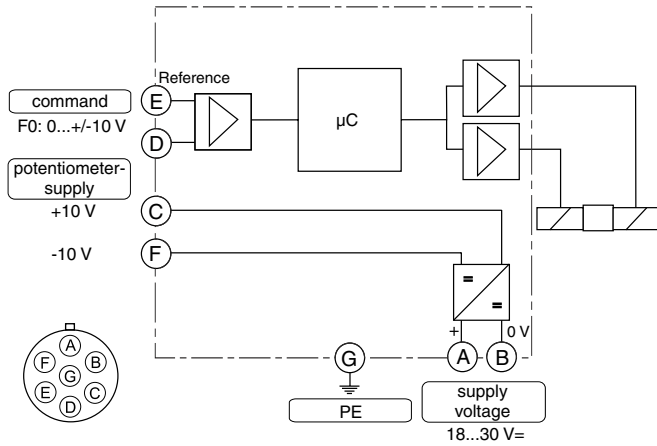

**Code G0, S0**  
 6 + PE acc. to EN 175201-804

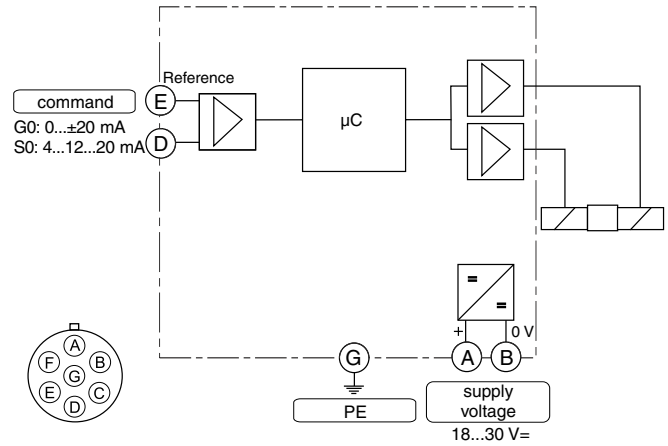

**Code W5**  
 11 + PE acc. to EN 175201-804

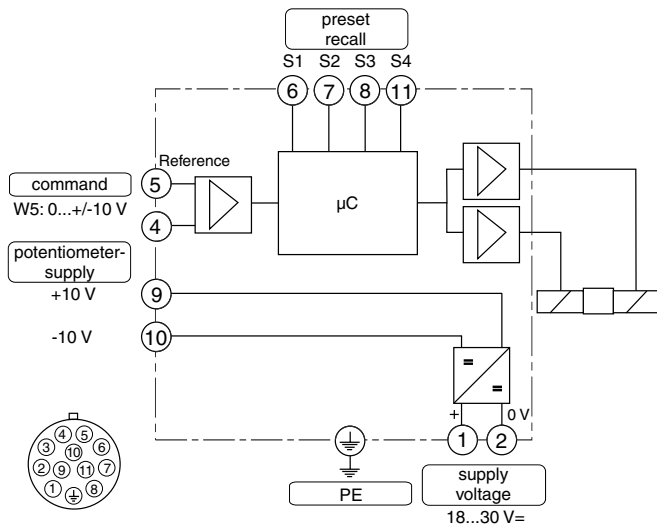

**3**

**ProPxD interface program**

The ProPxD software permits comfortable parameter setting for the module electronics. Via the clearly arranged entry mask the parameters can be noticed and modified. Storage of complete parameter sets is possible as well as printout or record as a text file for further documentation. Stored parameter sets may be loaded anytime and transmitted to other valves. Inside the electronics a non-volatile memory stores the data with the option for recalling or modification.

The PC software can be downloaded free of charge at [www.parker.com/euro\\_hcd](http://www.parker.com/euro_hcd) – see page "Support" or directly at [www.parker.com/propxd](http://www.parker.com/propxd).

**Features**

- Comfortable editing of all parameters
- Depiction and documentation of parameter sets
- Storage and loading of optimized parameter adjustments
- Executable with all actual Windows® operating systems from Windows® XP upwards
- Plain communication between PC and electronics via serial interface RS232C

**The parametrizing cable may be ordered under item no. 40982923.**

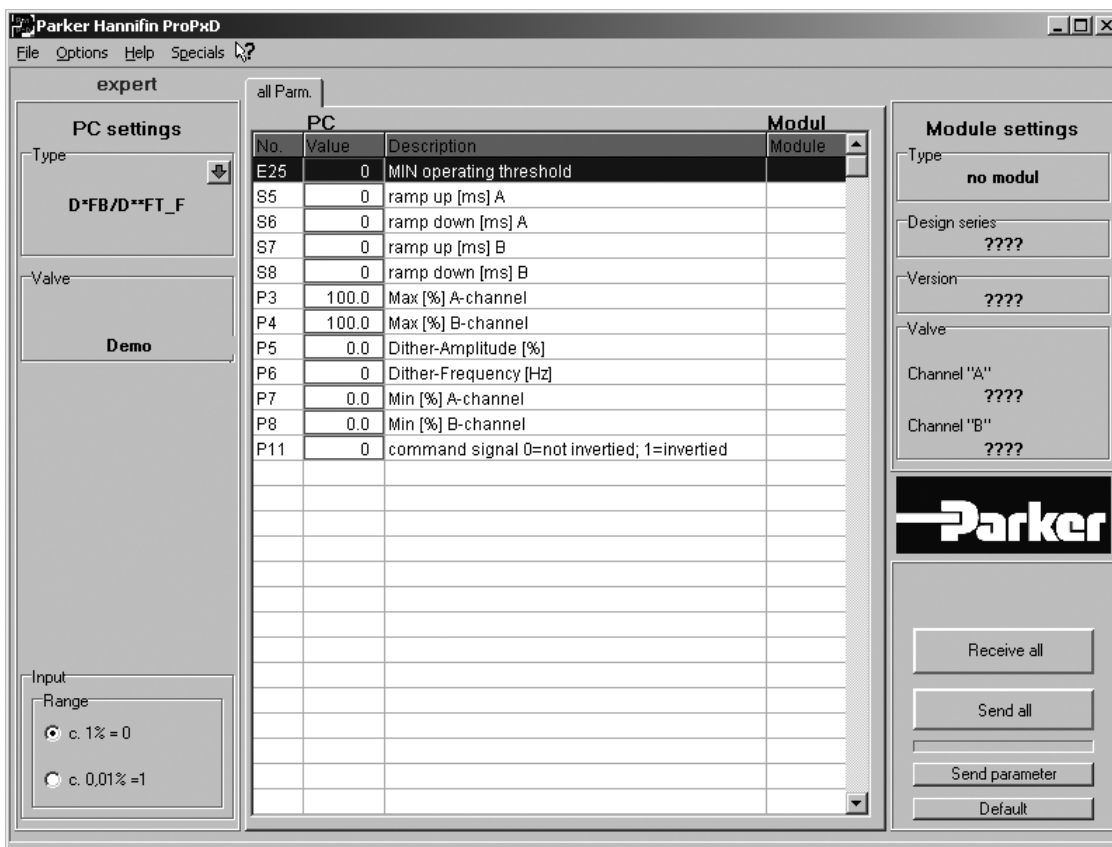



**3**

**D3FB\*C**

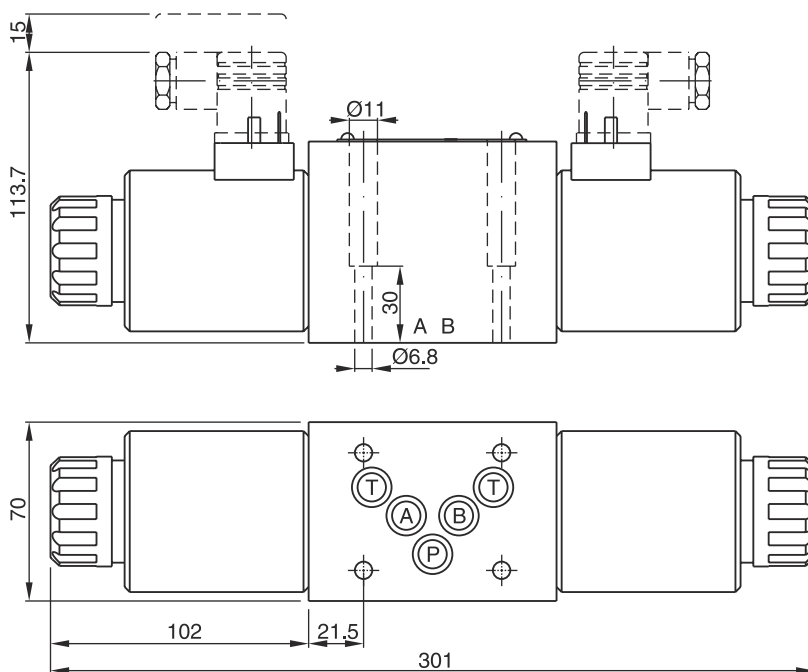



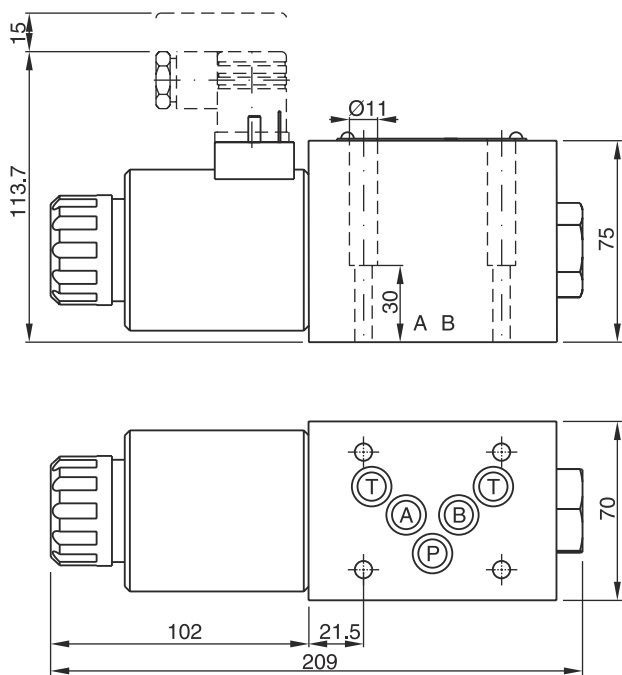

**D3FB\*E**

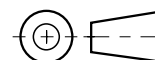
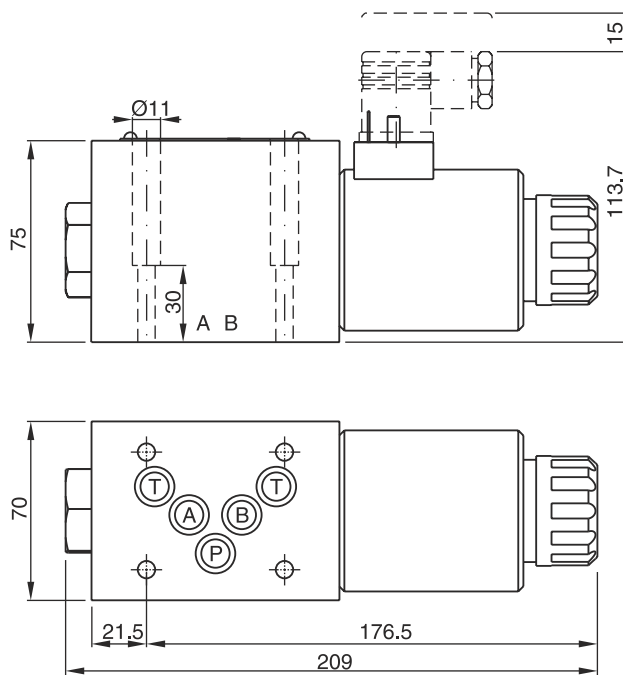

**D3FB\*K**

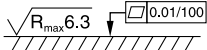

Surface finish	 Kit	 Kit	 Kit	 Kit <b>NBR</b>
	BK385	4x M6x40 ISO 4762-12.9	13.2 Nm ±15 %	SK-D3FB

**D3FB\*C OBE**

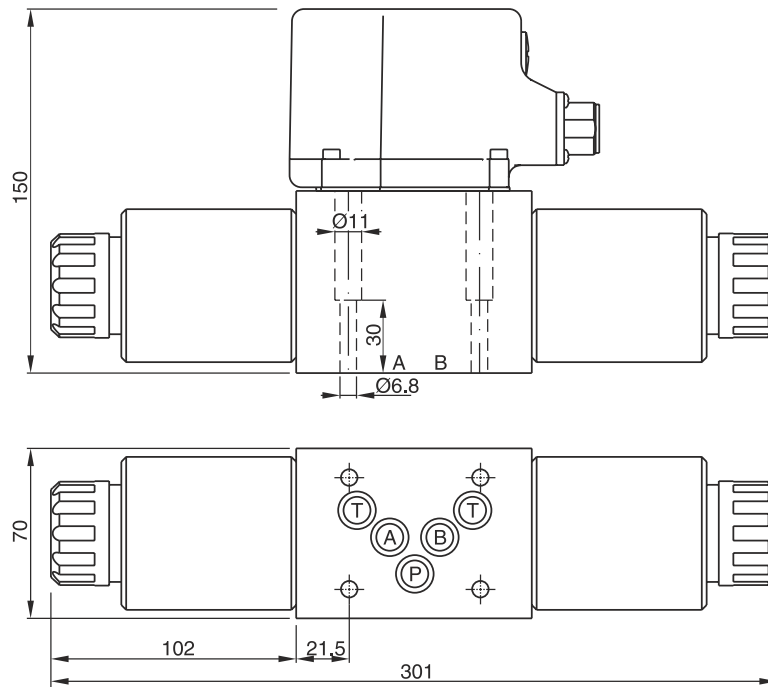



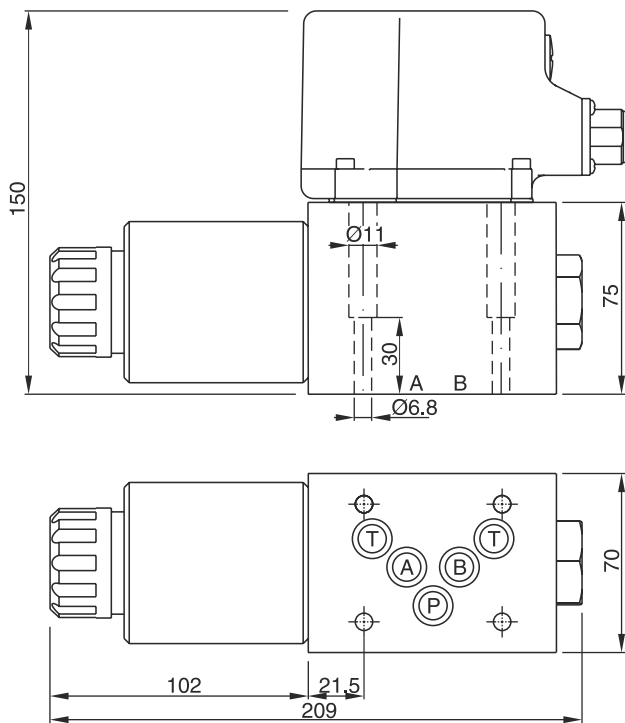

**D3FB\*E OBE**

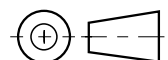
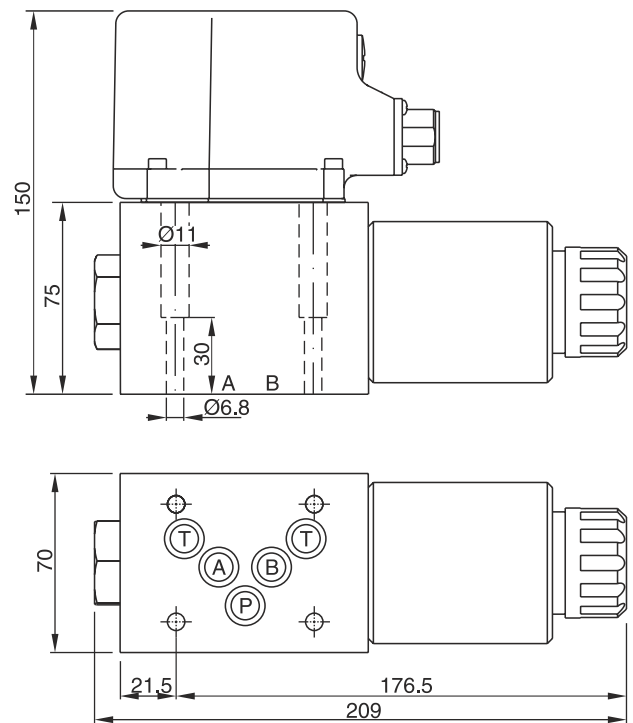

**D3FB\*K OBE**

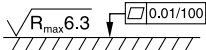

Surface finish	 Kit	 4x M6x40 ISO 4762-12.9	 13.2 Nm ±15 %	 Kit <b>NBR</b>
	BK385			SK-D3FB