

Characteristics

The proportional directional valves D1FB (NG06) are available with and without onboard electronics (OBE).

D1FB OBE:

The digital onboard electronics is situated in a robust metal housing, which allows the usage under rough environmental conditions.

The nominal values are factory set. The cable connection to a serial RS232 interface is available as accessory.

D1FB for external electronics:

The parameters can be saved, changed and duplicated in combination with the digital power amplifier PWD00A-400.

The valve parameters can be edited with the common ProPxD software for both versions.

The D1FB valves can be ordered with spool/sleeve design (D1FB*0) for maximum precision as well as spool/body design (D1FB*3) for high nominal flow - see functional limit curves for maximum flow capability.

Valves with explosion proof solenoids Ex e mb II see catalogue HY11-3343.

Download: www.parker.com/euro_hcd - see "Literature"



D1FB



D1FB OBE

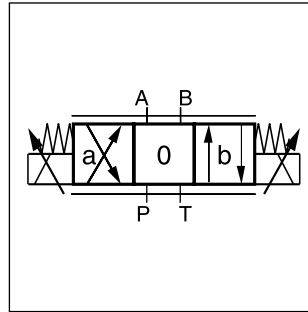

D1FB

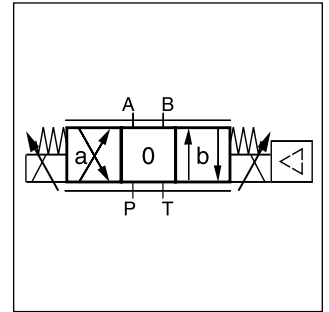

D1FB OBE

Features

- Spool/sleeve and spool/body
- 3 command options for D1FB OBE:
+/- 10 V, 4...20 mA, +/- 20 mA
- High repeatability from valve to valve
- Low hysteresis
- Manual override
- Digital onboard electronics
- Zero lap spools for the usage in simple closed loop systems

3

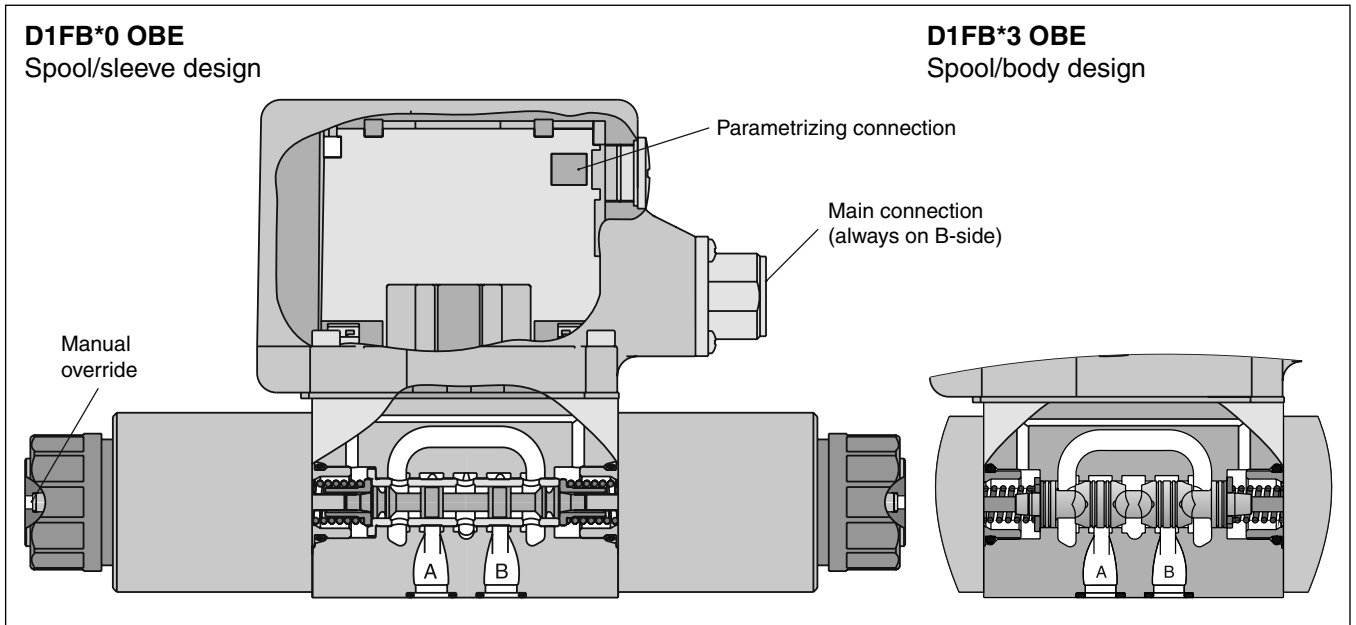

D1FB

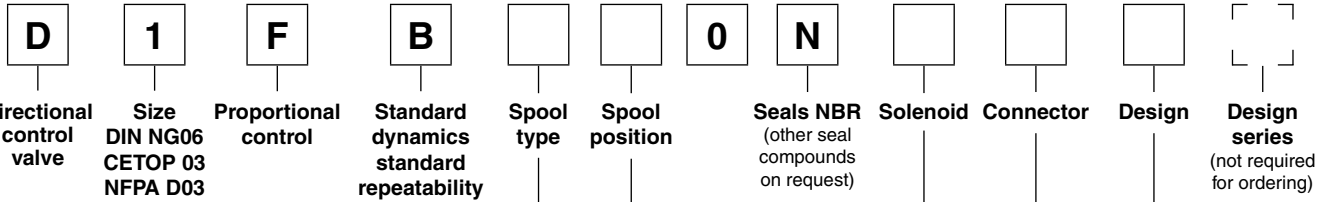

3

D1FB*0: Spool/sleeve design		
Code	Spool type	Flow [l/min] at Δp 5 bar per metering edge
Overlap		
E01C E01F E01H		6 12 20
E02C E02F E02H		6 12 20
E03C E03F E03H		6 12 20
B31F B31H	$Q_B = Q_A/2$ 	12 / 6 20 / 10
B32F B32H	$Q_B = Q_A/2$ 	12 / 6 20 / 10
Zero lap ¹⁾		
Code	Spool type	Flow [l/min] at Δp 35 bar per metering edge
E50C E50F E50H		6 12 20
B60F B60H	$Q_B = Q_A/2$ 	12 / 6 20 / 10

D1FB*3: Spool/body design		
Code	Spool type	Flow [l/min] at Δp 5 bar per metering edge
Overlap		
E01F E01H E01K		10 20 30
E02F E02H E02K		10 20 30
B31F B31H B31K	$Q_B = Q_A/2$ 	10 / 5 20 / 10 30 / 15
B32F B32H B32K	$Q_B = Q_A/2$ 	10 / 5 20 / 10 30 / 15

Code	Design
0	Spool/sleeve design
3	Spool/body design

Code	Connector
W ²⁾	Connector as per EN 175301-803
J ^{2) 3)}	Connector DT04-2P "Deutsch"

D1FB*0: Spool/sleeve design	
Code	Solenoid
M	9 V / 2.7 A
J	24 V / 0.8 A

D1FB*3: Spool/body design	
Code	Solenoid
K	12 V / 2.2 A
J	24 V / 1.1 A

Code	Design
C	
E	
K	

Short delivery time
for all variations

¹⁾ Only for spool position code C. No defined spool positioning at power down.
²⁾ Please order connector separately, see chapter 3 accessories.
³⁾ Not for spool/sleeve design.

D1FB OBE (with onboard electronics)

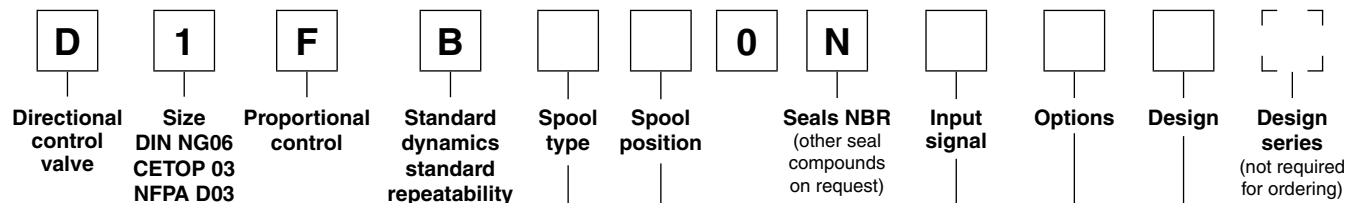

D1FB*0: Spool/sleeve design		
Code	Spool type	Flow [l/min] at Δp 5 bar per metering edge
Overlap		
E01C E01F E01H		6 12 20
E02C E02F E02H		6 12 20
E03C E03F E03H		6 12 20
B31F B31H	$Q_B = Q_A/2$ 	12 / 6 20 / 10
B32F B32H	$Q_B = Q_A/2$ 	12 / 6 20 / 10
Zero lap ¹⁾		
Code	Spool type	Flow [l/min] at Δp 35 bar per metering edge
E50C E50F E50H		6 12 20
B60F B60H	$Q_B = Q_A/2$ 	12 / 6 20 / 10

D1FB*3: Spool/body design		
Code	Spool type	Flow [l/min] at Δp 5 bar per metering edge
Overlap		
E01F E01H E01K		10 20 30
E02F E02H E02K		10 20 30
B31F B31H B31K	$Q_B = Q_A/2$ 	10 / 5 20 / 10 30 / 15
B32F B32H B32K	$Q_B = Q_A/2$ 	10 / 5 20 / 10 30 / 15

Code	Design
0	Spool/sleeve design
3	Spool/body design

Code	Input signal ³⁾	Function	Port	Options
F0	0...+/-10 V	0...+10 V > P-A	6 + PE	Potentiometer supply
G0	0...+/-20 mA	0...+20 mA > P-A	6 + PE	—
S0	4...20 mA	12...20 mA > P-A	6 + PE	—
W5 ²⁾	0...+/-10 V 4...20 mA	0...+10 V > P-A 12...20 mA > P-A	11 + PE	Command channel & potentiometer supply

Code	Design
C	
E	
K	

Please order connector separately, see chapter 3 accessories.
 Parametrizing cable OBE → RS232: Item no. 40982923

Short delivery time for all variations

¹⁾ Only for spool position code C. No defined spool positioning at power down.
²⁾ Factory set ± 10 V on delivery.
³⁾ Single solenoid always 0...+10 V respectively 4...20 mA.

3

General			
Design	Direct operated proportional DC valve		
Actuation	Proportional solenoid		
Size	NG06/CETOP 03/NFPA D03		
Mounting interface	DIN 24340 / ISO 4401 / CETOP RP121 / NFPA		
Mounting position	unrestricted		
Ambient temperature	[°C]	-20...+60	
MTTF _D value ¹⁾	[years]	150	
Weight (OBE)	[kg]	2.2 (2.9)	
Vibration resistance	[g]	10 Sinus 5...2000 Hz acc. IEC 68-2-6	
		30 Random noise 20...2000 Hz acc. IEC 68-2-36	
		15 Shock acc. IEC 68-2-27	
Hydraulic			
Max. operating pressure	[bar]	Ports P, A, B 350; Port T 210	
Max. pressure drop PABT / PBAT	[bar]	350	
Fluid	Hydraulic oil according to DIN 51524 ... 535, other on request		
Fluid temperature	[°C]	-25...+60	
Viscosity permitted	[cSt] / [mm ² /s]	20...400	
	recommended	[cSt] / [mm ² /s]	30...80
Filtration	ISO 4406 (1999); 18/16/13		
Nominal flow at Δp = 5 bar per control edge ²⁾	[l/min]	D1FB*0 (Spool/sleeve)	D1FB*3 (Spool/body)
		6 / 12 / 20	10 / 20 / 30
Leakage at 100 bar	[ml/min]	<50 (overlapped spool); <400 (zerolapped spool)	<60
Opening point (OBE)	[%]	see flow characteristics (set to 10 command signal)	
Static / Dynamic			
Step response at 100 % step	[ms]	30	30
Hysteresis	[%]	<4	<6
Temperature drift solenoid current	[%/K]	<0.02	
Electrical characteristics			
Duty ratio	[%]	100 ED; CAUTION: Coil temperature up to 150 °C possible	
Protection class	Standard (as per EN 175301-803) IP65 in accordance with EN 60529 (with correctly mounted plug-in connector) DT04-2P "Deutsch" IP69K (with correctly mounted plug-in connector)		
Solenoid		Code "M"	Code "K" Code "J" (Spool/sleeve)
Supply voltage	[V]	9	12 24
Current consumption	[A]	2.7	2.2 1.1 (0.8)
Resistance	[Ohm]	2.7	4.4 18.6
Solenoid connection	Connector as per EN 175301-803 (code W), DT04-2P "Deutsch" connector (code J). Solenoid identification as per ISO 9461.		
Wiring min.	[mm ²]	3x1.5 (AWG 16) overall braid shield (Code W), "Deutsch" connector DP4 2-Pin (Code J)	
Wiring length max.	[m]	50	

¹⁾ If valves with onboard electronics are used in safety-related parts of control systems, in case the safety function is requested, the valve electronics voltage supply is to be switched off by a suitable switching element with sufficient reliability.

²⁾ Flow rate for different Δp per control edge: $Q_x = Q_{Nom.} \cdot \sqrt{\frac{\Delta p_x}{\Delta p_{Nom.}}}$

Electrical characteristics OBE		
Duty ratio	[%]	100 ED; CAUTION: Coil temperature up to 150 °C possible
Protection class		IP65 in accordance with EN 60529 (with correctly mounted plug-in connector)
Supply voltage/ripple DC	[V]	18...30, ripple < 5 % eff., surge free
Current consumption max.	[A]	2.0
Pre fusing medium lag	[A]	2.5
Input signal		
Codes F0 & W5 voltage	[V]	+10...0...-10, ripple < 0.01 % eff., surge free, Ri = 100 kOhm, 0...+10 V ⇒ P -> A
Codes S0 & W5 current	[mA]	4...12...20, ripple < 0.01 % eff., surge free, Ri = <250 Ohm, 12...20 mA ⇒ P -> A < 3.6 mA = enable off, > 3.8 mA = enable on (acc. to NAMUR NE43)
Code G0	[mA]	+20...0...-20, ripple < 0.01 % eff., surge free, Ri = <250 Ohm, 0...+20 mA ⇒ P -> A
Differential input max.		
Codes F0, G0 & S0	[V]	30 for terminal D and E against PE (terminal G) 11 for terminal D and E against 0V (terminal B)
Code W5	[V]	30 for terminal 4 and 5 against PE (terminal PE) 11 for terminal 4 and 5 against 0V (terminal 2)
Channel recall signal	[V]	0...2.5: off / 5...30: on / Ri = 100 kOhm
Adjustment ranges		
Min	[%]	0...50
Max	[%]	50...100
Ramp	[s]	0...32.5
Interface		RS 232, parametrizing connection 5pole
EMC		EN 61000-6-2, EN 61000-6-4
Central connection		
Codes F0, G0 & S0		6 + PE acc. to EN 175201-804
Code W5		11 + PE acc. to EN 175201-804
Wiring min.		
Codes F0, G0 & S0	[mm ²]	7 x 1.0 (AWG16) overall braid shield
Code W5	[mm ²]	11 x 1.0 (AWG16) overall braid shield
Wiring length max.		50

3

Flow characteristics

D1FB*0 external electronics

at $\Delta p = 5$ bar per metering edge

Spool type E01/02/03, B31/32

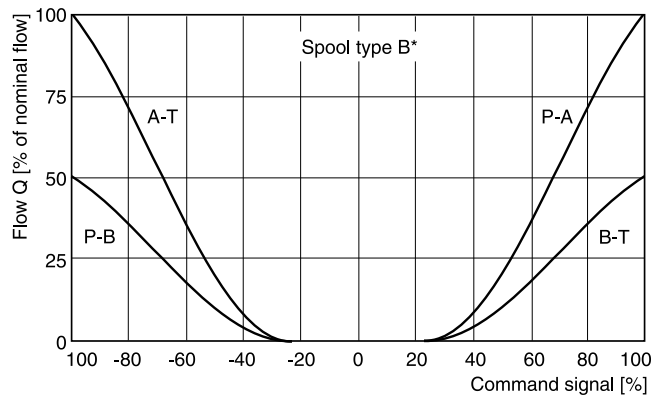
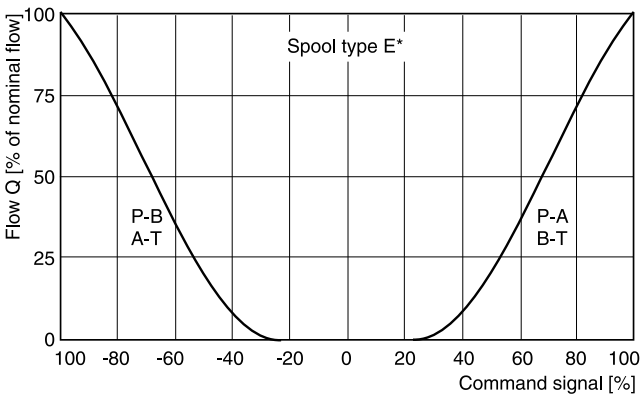

D1FB*0 OBE

(set to opening point 10 %)

at $\Delta p = 5$ bar per metering edge

Spool type E01/02/03, B31/32

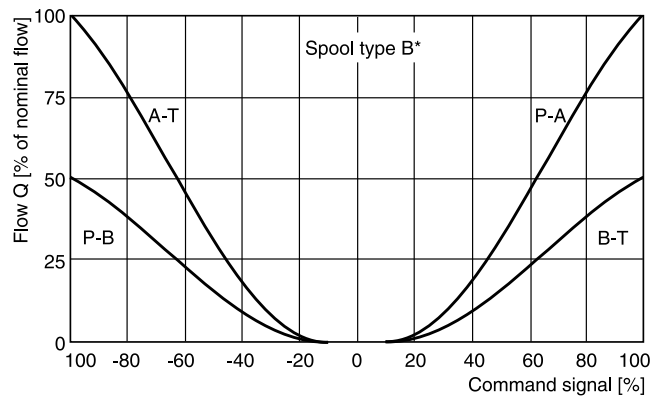
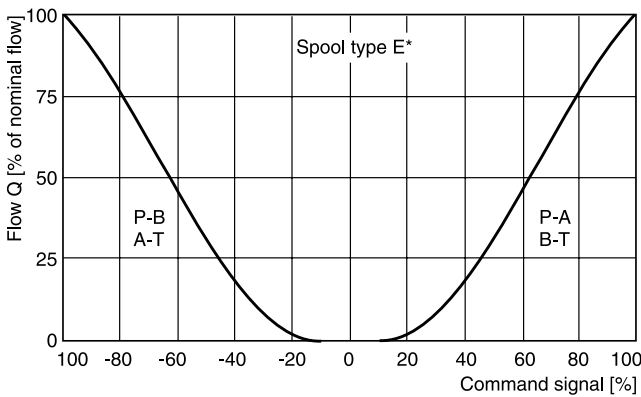

Functional limits

at 25 %, 50 %, 75 % and 100 % command signal
 (symmetric flow)

Spool type E01H

At asymmetric flow a reduced flow limit has to be considered.

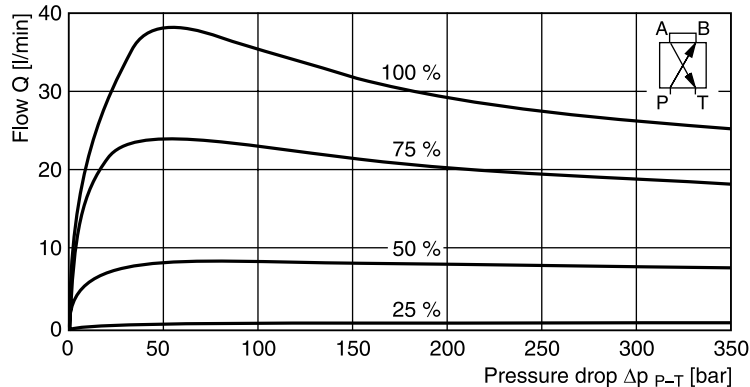

All characteristic curves measured with HLP46 at 50 °C.

**Flow characteristics
 D1FB*3 external electronics**
 at $\Delta p = 5$ bar per metering edge
 Spool type E01/02/03, B31/32

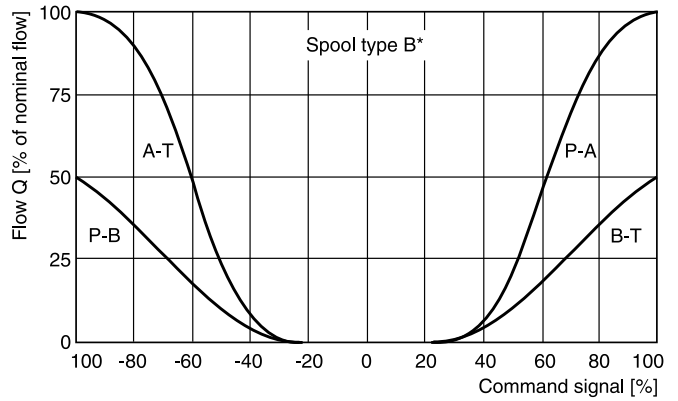
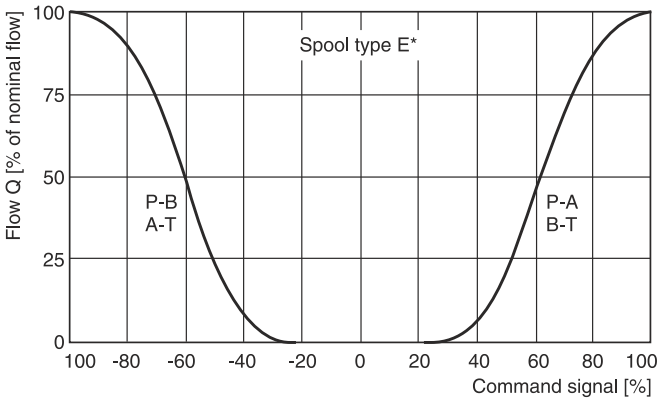

D1FB*3 OBE
 (set to opening point 10 %)
 at $\Delta p = 5$ bar per metering edge
 Spool type E01/02

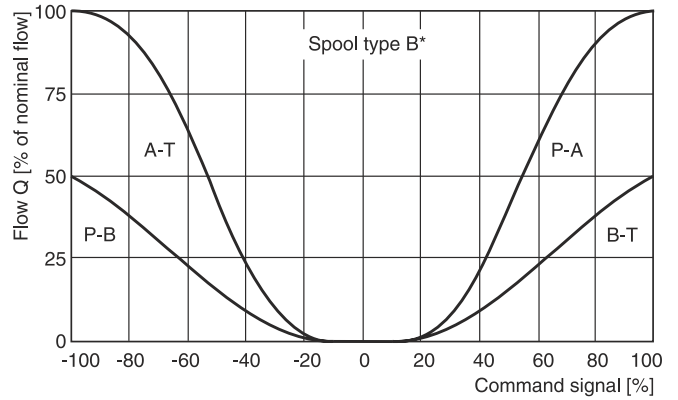
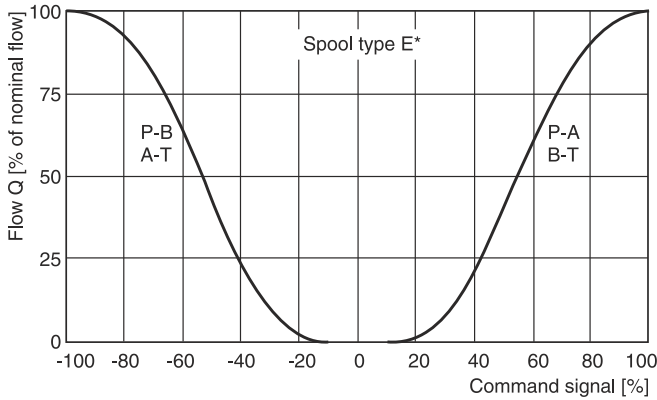

Functional limits
 at 25 %, 50 %, 75 % and 100 % command signal
 (symmetric flow)
Spool type E01K

At asymmetric flow a reduced flow limit has to be considered.

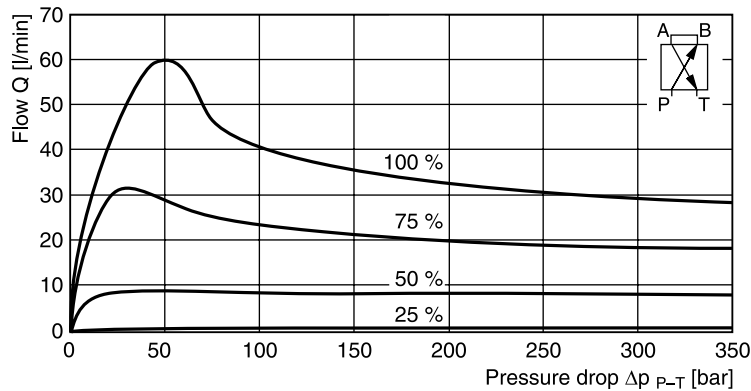

All characteristic curves measured with HLP46 at 50 °C.

Code F0
 6 + PE acc. to EN 175201-804

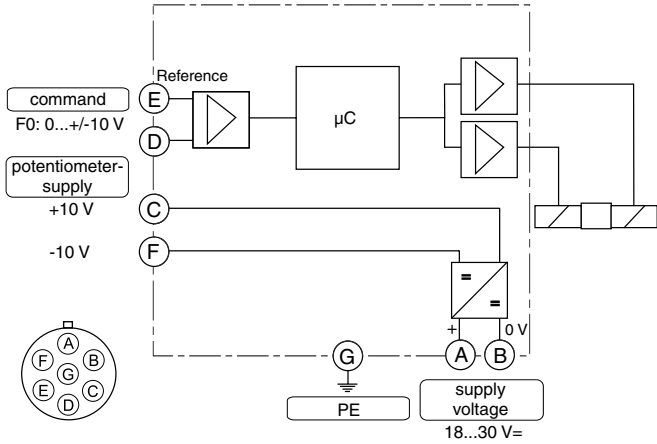

Code G0, S0
 6 + PE acc. to EN 175201-804

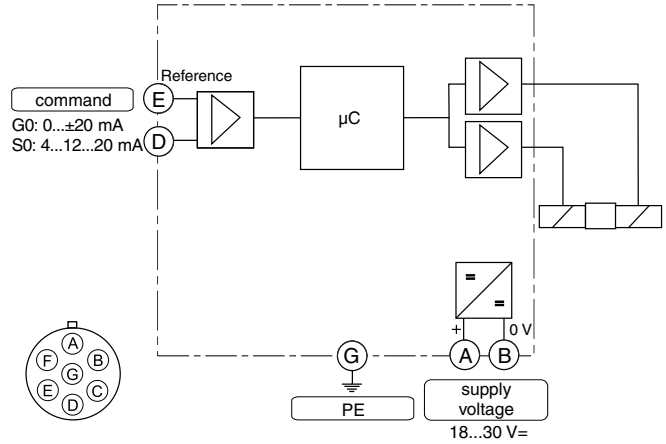

Code W5
 11 + PE acc. to EN 175201-804

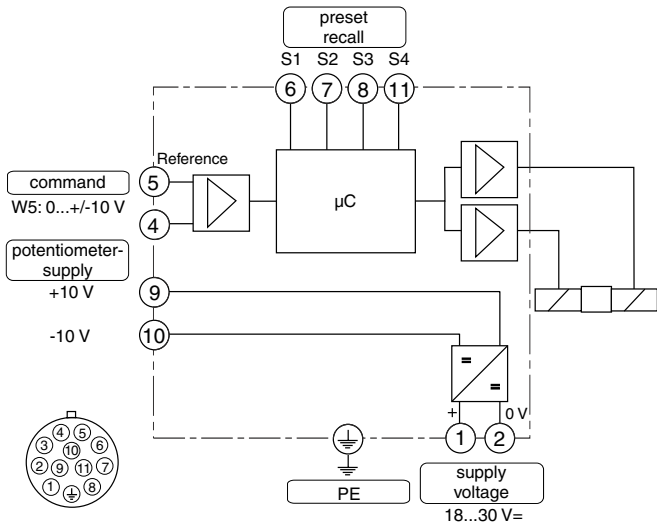

3

ProPxD interface program

The ProPxD software permits comfortable parameter setting for the module electronics. Via the clearly arranged entry mask the parameters can be noticed and modified. Storage of complete parameter sets is possible as well as printout or record as a text file for further documentation. Stored parameter sets may be loaded anytime and transmitted to other valves. Inside the electronics a non-volatile memory stores the data with the option for recalling or modification.

The PC software can be downloaded free of charge at www.parker.com/euro_hcd – see page "Support" or directly at www.parker.com/propxd.

Features

- Comfortable editing of all parameters
- Depiction and documentation of parameter sets
- Storage and loading of optimized parameter adjustments
- Executable with all actual Windows® operating systems from Windows® XP upwards
- Plain communication between PC and electronics via serial interface RS232C

The parametrizing cable may be ordered under item no. 40982923.

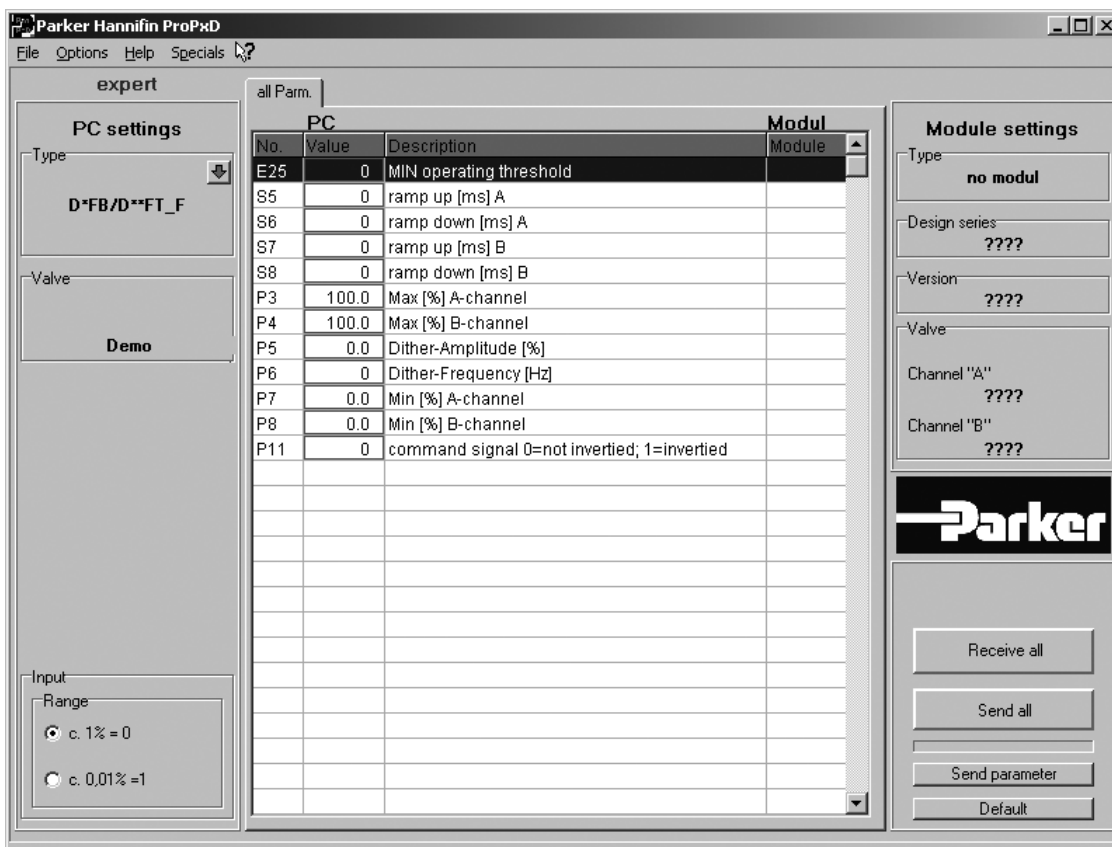

D1FB*C

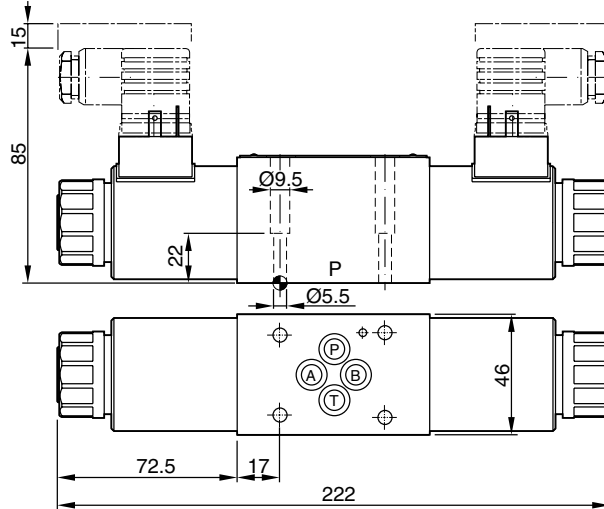

D1FB*E

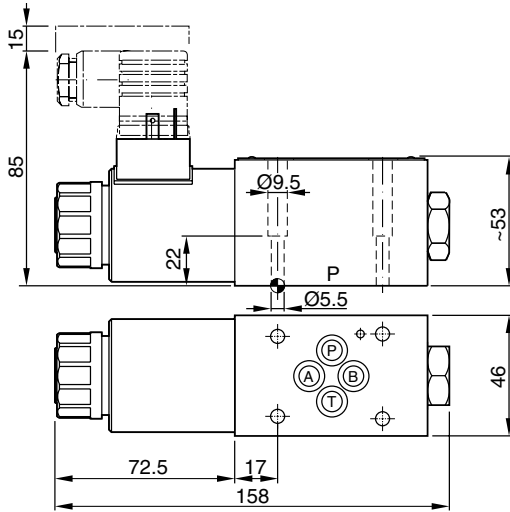

D1FB*K

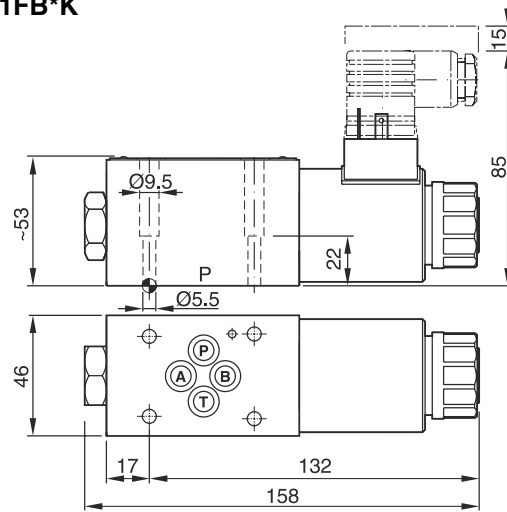



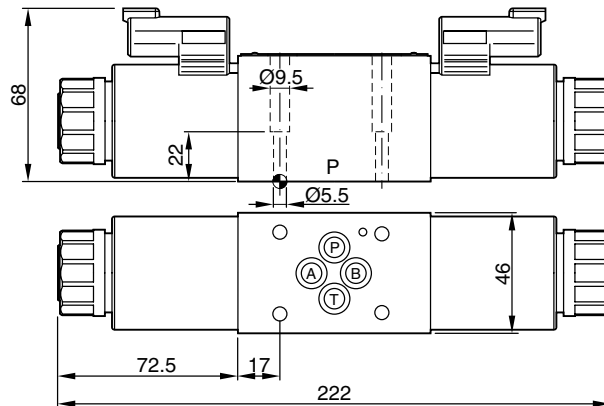

D1FB*C*0 with DT04-2P "Deutsch" connector
 (only C style shown)

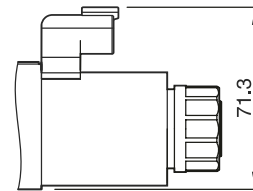

D1FB*C*3

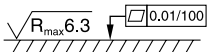

Surface finish	 Kit	 Kit	 Kit	 Kit NBR
	BK375	4x M5x30 ISO 4762-12.9	7.6 Nm ±15 %	SK-D1FB

3

D1FB*C OBE

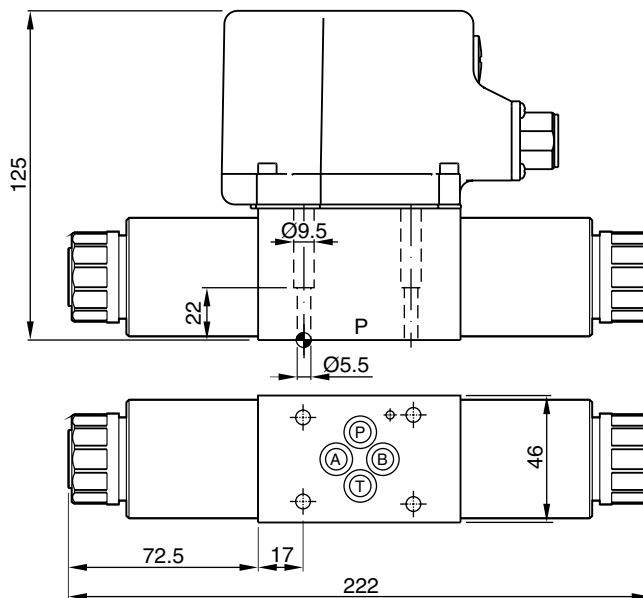



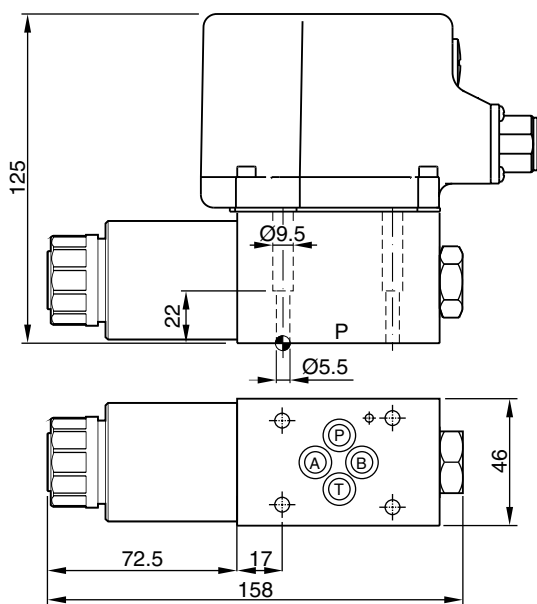

3

D1FB*E OBE

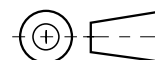
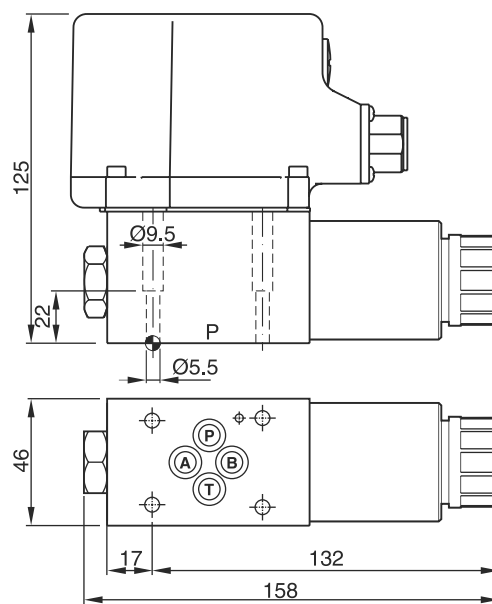

D1FB*K OBE

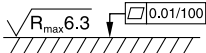

Surface finish	 Kit			 Kit NBR
	BK375	4x M5x30 ISO 4762-12.9	7.6 Nm ±15 %	SK-D1FB